

Solid Carbide End Mills



Tool Factory Fanar Joint Stock Company is a leading manufacturer of cutting tools for metalworking.

For many years, we focus on innovation, quality and continuous development. Our knowledge and experience, which is supported by **newest technology and modern stock of machine tools** allow us to offer innovative products meeting highest quality requirements. We are trusted supplier in the country and abroad. We are cooperating with the world's biggest producers of such industries as: automotive, aerospace, medical, home appliances and many others.

A wide range of products supported by service, technical advice, and IT new solutions in customer service ensure a high level of customer **s a t i s f a c t i o n .**



We are producer
with global reach

Our tools are distributed to more than **40 countries**. More and more recognizable brand of producer of the highest quality allows for further international expansion. Looking for **tools of the highest quality thread** take advantage of our global distribution network. The current list of official distributors available on the

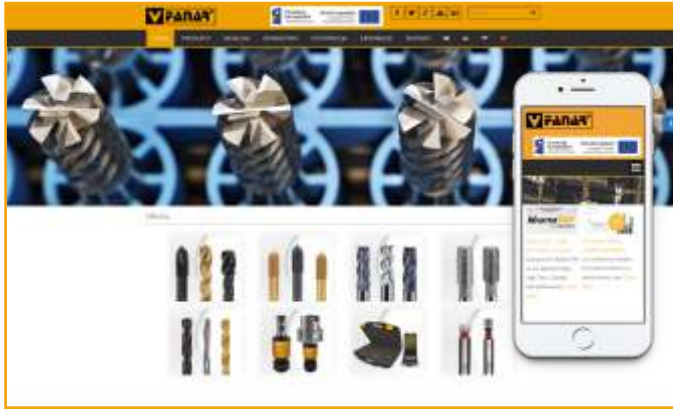

PVD coatings

TS TiAlN + TiAlSiN
 AT AlTiN
 TB TiB₂
 AD AlCrN

PVD Uncoated

Shank type

Straight shank acc. to DIN-6535-HA
 Weldon shank acc. to DIN-6535-HB

Cutting geometry

Z=4 Number of flutes Possible feed directions
 Square corner Corner radius
 Ball nose For High Feed Machining
40° Helix angle 35°-39° Variable helix angle
 Equal pitch Unequal pitch
Typ HR Chip breaker

- - Primary application
- - Secondary application

The speed values are orientational.
The speed should be adjust experimentally

Example

Material number

		Example	Material number		
220		11SMnPb30, 10SPb20, 35S20, 11SMn37	1.0718, 1.0722, 1.0726, 1.0736	P1	P
190	-	S235JR, S275JR, C22, C45	1.0038, 1.0044, 1.0402, 1.0503	P2	
190	-	C55, C60, C60E	1.0535, 1.0601, 1.1221	P3	
210	-	C25E, C53G, G18Mo5, 16Mo5	1.1158, 1.1213, 1.5422, 1.5423	P4	
300	32	C55, C55E, C60E	1.0535, 1.1203, 1.1221	P5	
175	-	36Mn5, 107CrV3, 100Cr6, 20NiCrMo2-2, 41Cr4	1.1167, 1.2210, 1.3505, 1.6523, 1.7035	P6	
300	32	34Cr4, 25CrMo4, Weldox 700, Weldox 900	1.7033, 1.7218	P7	
380	41	36NiCr6, 34CrNiMo6, 55Cr3, 51CrV4	1.5710, 1.6582, 1.7176, 1.8159	P8	
120	45	55Si7, 60SiCr7, 55NiCrMoV6, 40CrMoV13-9	1.0904, 1.0961, 1.2713, 1.8523	P9	
210	-	X210Cr12, X100CrMoV5-1, HS6-5-2-5, HS6-5-2	1.2080, 1.2363, 1.3243, 1.3343	P10	
300	32	HS6-5-2-5, HS18-1-2-5, HS 10-2-5-8, HS 6-5-3-8	1.3243, 1.3255, 1.3253, 1.3294	P11	
120	45	X30WCrV9-3	1.2581	P12	
210	-	X6Cr13, X12Cr13, X14CrMoS17, X6CrMo17-1	1.4000, 1.4006, 1.4104, 1.4113	P13	
330	34	X12Cr13, GX20Cr14, X19CrNi17-2, X45CrSi9-3-1	1.4006, 1.4027, 1.4057, 1.4718	P14	
210	-	X5CrNi18-10, X5CrNiMo17-12-2, X2CrNiMo18-14-3, X12NiCrSi36-16	1.4301, 1.4401, 1.4435, 1.4864	M1	M
300	32	X9CrNi18-8, X53CrMnNiN21-9	1.4310, 1.4871	M2	
240	23	X2CrNiN23-4, X2CrNiMoN17-13-3, X2CrNiMoN22-5-3, X2CrNiMoCuN25-6-3	1.4362, 1.4429, 1.4462, 1.4507	M3	
120	-	EN-GJL-100, EN-GJL-200, EN-GJL-300, EN-GJL-400	0.6010, 0.6020, 0.6030, 0.6040	K1	K
160	-	EN-GJV-300, EN-GJV-400, EN-GJV-500, EN-GJV-550	-	K2	
150	-	EN-GJMW-300-26, EN-GJMB-350-10, EN-GJMB-450-6	0.8035, 0.8135, 0.8145	K3	
240	-	EN-GJMB-550-4, EN-GJMB-700-2, EN-GJMB-800-1	0.8155, 0.8170, 0.8180	K4	
210	-	EN-GJS-400-15, EN-GJS-500-7, EN-GJS-700-2	0.7040, 0.7050, 0.7070	K5	
120	45	EN-GJS-800-8, EN-GJS-1200-2, EN-GJS-1400-1	-	K6	
-	-	ENAW-AI99.5, ENAW-AISI1MgMn (PA4), ENAW-AIMg0.7Si (PA38), ENAW-AIMg3 (PA11)	3.0255, 3.2315, 3.3206, 3.3535	N1	N
152	-	ENAW-AICu6BiPb, ENAW-AICu4MgSi(A) (PA6), ENAW-AIZn5.5MgCu (PA9) ENAW-AIMg4.5Mn0.7 (PA13)	3.1655, 3.1325, 3.4365, 3.3547	N2	
75	-	ENAC-AISI12, ENAC-AISI12(Fe), ENAC-AISI12(Cu), ENAC-AIMg5	3.2581, 3.2582, 3.2583, 3.3561	N3	
90	-	ENAC-AICu4MgTi, ENAC-AISI7Mg0.3, ENAC-AISI9Mg, ENAC-AISI10Mg(a)	3.1371, 3.2371, 3.2373, 3.2381	N4	
130	-	ENAC-AISI17Cu4Mg	-	N5	
70	-	EN-MAMgMn1, EN-MCMgRE3Zn2Zr, EN-MCMgRE2Ag2Zr, EN-MCMgAl4Si	3.5101, 3.5103, 3.3506, 3.5470	N6	
100	-	Cu-OF, Cu-DHP, CuZn35Mn2Al1Fe1-C, CuAl10Ni5Fe4	2.0040, 2.0090, 2.0592, 2.0966	N7	
180	-	CuZn37 (M63), CuAl10Ni5Fe4, CuSn8P	2.0321, 2.0966, 2.1030	N8	
120	-	CuZn40Pb2 (M58)(MO58), CuSn7Zn4Pb7-C, CuSn5Zn5Pb5-C, CuSn10Pb10-C	2.0402, 2.1090, 2.1096, 2.1176	N9	
300	32	AMPCO 8, AMPCO 21, AMPCO M4	-	N10	
200	-	Incoloy 909, Multimet 155, X10NiCrAlTi3220 (Incoly 800), X40CoCrNi2020	1.4876, 1.4977	S1	S
280	29	Incoloy A-286, Unitemp 212	-	S2	
250	25	Incoloy 864, Nimocast 713	-	S3	
350	38	Inconel 718, Nimonic 80A	-	S4	
320	34	GMR 235*, Jessop G81*	-	S5	
200	-	Ti 99.8, TiCu2	3.7025, 3.7124	S6	
375	40	Ti-6Al-4V, Ti-6Al-2Mo-2Cr, Ti-6Al-6Mo-4Zr-2Sn	3.7165	S7	
110	44	Ti-10V-2Fe-3Al, Ti-13V-11Cr-3Al	-	S8	
50		Weldox 1100, Weldox 1300, Hardox 500	-	H1	H
55		Hardox 550, Hardox 600, Armax 600 T	-	H2	
60		Hardox Extreme	-	H3	
55		GX260NiCr42, GX330NiCr42, GX300CrMoNi15-2-1	0.9620, 0.9625, 0.9640	H4	

Material group

Groups of Tools by Applications

MASTERMILL

High performance end mills dedicated to work on machining centers, for machining steel, stainless steel up to 45 HRC, cast iron and difficult to machine materials based on titanium and nickel.

X-MILL

General purpose end mills for machining materials with hardness up to 35 HRC.

HRC

End mills produced of comented carbide grade with nano-grain size (< 0,2µm), dedicated for machining materials in hardened condition. Optimized geometry and TS coating allow machining materials with higher hardness than 65 HRC.

AL

Group of tools with cutting geometry optimized to machining non-ferrous materials. Polished flutes and TB coating allow high performance machining of aluminium and copper alloys.

			Annealed	A				
			Tempered	QT				
			Hardened and tempered	HT				
			Precipitation hardened	PH				
					Rm	HB	HRC	
Steel								
P	P1	Free cutting steel	A	750	220			
	P2	Non-alloyed steel	C ≤ 0,55 %	A	650	190	-	
	P3		C > 0,55 %	A	650	190	-	
	P4	Low-alloyed steel	C ≤ 0,55 %	QT	700	210	-	
	P5		C > 0,55 %	QT	1000	300	32	
	P6	High-alloyed steel and high-alloyed tool steel	A	600	175	-		
	P7		QT	1000	300	32		
	P8		QT	1200	380	41		
	P9	Stainless steel	QT	1400	420	45		
	P10		A	700	210	-		
	P11		A	1000	300	32		
	P12		HT	1400	420	45		
	P13	Stainless steel	Ferritic/martensitic	A	700	210	-	
	P14		Martensitic	QT	1100	330	34	
Stainless steel								
M	M1	Austenitic		700	210	-		
	M2	Austenitic (PH)	PH	1000	300	32		
	M3	Duplex		800	240	23		
Cast iron								
K	K1	Grey cast iron(GJL)		400	120	-		
	K2	Cast iron with vermicular graphite (GJV) CGI		550	160	-		
	K3	Malleable cast iron (GJMW / GJMB)		500	150	-		
	K4	Malleable cast iron (GJMB)		800	240	-		
	K5	Cast iron with spheroidal graphite (GJS)		700	210	-		
	K6	Cast iron with spheroidal graphite (GJS) ADI		1400	420	45		
Non-ferrous metals								
N	N1	Aluminium wrought alloys		200	-	-		
	N2		PH	500	152	-		
	N3	Cast aluminium alloys	Si ≤ 12%	250	75	-		
	N4		Si ≤ 12%	PH	300	90	-	
	N5		Si > 12 %		450	130	-	
	N6	Magnesium alloys		250	70	-		
	N7	Copper and copper alloys	Pure, Non-alloyed		350	100	-	
	N8		Cu-alloys, long-chipping		600	180	-	
	N9		Cu-alloys, short-chipping		400	120	-	
	N10		High-strength,		1000	300	32	
Superalloys and titanium								
S	S1	Heat-resistant alloys	Fe-based	A	675	200	-	
	S2		PH	950	280	29		
	S3		Ni / Co base	A	850	250	25	
	S4		PH	1200	350	38		
	S5	Titanium alloys	C	1100	320	34		
	S6		Pure titanium		675	200	-	
	S7		α and β alloys		1250	375	40	
	S8		β alloys		1400	410	44	
Hard materials								
H	H1	Hardened steel	HT			50		
	H2		HT			55		
	H3		HT			60		
	H4	Hardened cast iron	HT			55		

Material group



MASTERMILL



<p>For machining steel and cast iron with hardness up to 45 HRC, stainless steel and difficult to machine materials</p>								MASTERMILL	
								440N	R440N
Workpiece material									
Shank									
Tool material								VHM	VHM
Coating								TS	TS
Corner type									
d ₁	d ₂ h6	d ₃	l ₁	l ₂	l ₃	Z	R	INDEX	
6	6	5,5	57	13	21	4	0,25	M9-44GMA0-0060	M9-44GMAC-0060
6	6	5,5	57	13	21	4	0,5	-	M9-44GMA1-0060
8	8	7,5	63	19	27	4	0,5	M9-44GMA0-0080	M9-44GMA1-0080
10	10	9,5	72	22	32	4	0,5	M9-44GMA0-0100	M9-44GMA1-0100
12	12	11,5	83	26	38	4	0,5	M9-44GMA0-0120	M9-44GMA1-0120
14	14	13	83	26	38	4	0,5	M9-44GMA0-0140	M9-44GMA1-0140
16	16	15	92	32	44	4	0,5	M9-44GMA0-0160	M9-44GMA1-0160
16	16	15	92	32	44	4	1	-	M9-44GMA3-0160
18	18	17	92	32	44	4	0,5	M9-44GMA0-0180	M9-44GMA1-0180
20	20	19	104	38	55	4	0,5	M9-44GMA0-0200	M9-44GMA1-0200
20	20	19	104	38	55	4	1	-	M9-44GMA3-0200

ISO	V _c [m/min]	d, [mm]								
		6	8	10	12	14	16	18	20	
		fz [mm]	fz [mm]	fz [mm]	fz [mm]	fz [mm]	fz [mm]	fz [mm]	fz [mm]	fz [mm]
P	P1-P4	150-200	0,020	0,030	0,045	0,055	0,060	0,065	0,070	0,080
	P5-P12	120-160	0,015	0,030	0,040	0,045	0,050	0,055	0,060	0,065
	P13	70-130	0,010	0,020	0,020	0,035	0,040	0,045	0,050	0,055
	P14	70-110	0,010	0,020	0,020	0,035	0,040	0,045	0,050	0,055
M	M1	80-120	0,010	0,020	0,020	0,035	0,040	0,045	0,050	0,055
	M2-M3	60-100	0,015	0,025	0,040	0,045	0,050	0,055	0,060	0,065
K	K1-K6	140-200	0,020	0,025	0,040	0,045	0,050	0,055	0,060	0,065
N	N1-N5	240-280	0,050	0,055	0,065	0,075	0,080	0,085	0,090	0,095
	N7-N10	260-300	0,050	0,055	0,060	0,070	0,075	0,080	0,085	0,090
S	S1-S5	30-50	0,020	0,030	0,050	0,055	0,060	0,065	0,070	0,075
	S6-S8	40-70	0,020	0,035	0,050	0,055	0,060	0,065	0,070	0,075

For machining steel and cast iron with hardness up to 45 HRC, stainless steel and difficult to machine materials

MASTERMILL

B440N

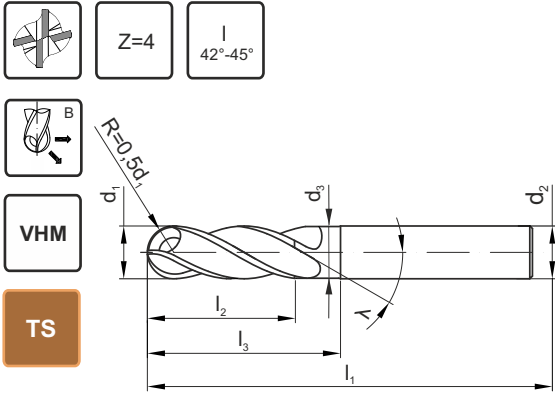

Workpiece material



Shank



Tool material

VHM

Coating

TS

Corner type



d ₁	d ₂ h6	d ₃	l ₁	l ₂	l ₃	Z	R	INDEX
3	6	-	57	8	-	4	1,5	M9-44GMAX-0030
4	6	-	57	11	-	4	2,0	M9-44GMAX-0040
5	6	-	57	13	-	4	2,5	M9-44GMAX-0050
6	6	5,5	57	13	21	4	3,0	M9-44GMAX-0060
8	8	7,5	63	19	27	4	4,0	M9-44GMAX-0080
10	10	9,5	72	22	32	4	5,0	M9-44GMAX-0100
12	12	11,5	83	26	38	4	6,0	M9-44GMAX-0120
14	14	13	83	26	38	4	7,0	M9-44GMAX-0140
16	16	15	92	32	44	4	8,0	M9-44GMAX-0160
18	18	17	92	32	44	4	9,0	M9-44GMAX-0180
20	20	19	104	38	55	4	10,0	M9-44GMAX-0200

ISO	V _c [m/min]	d, [mm]											
		3	4	5	6	8	10	12	14	16	18	20	
		fz [mm]	fz [mm]	fz [mm]	fz [mm]	fz [mm]	fz [mm]	fz [mm]	fz [mm]	fz [mm]	fz [mm]	fz [mm]	fz [mm]
P	P1-P4	150-200	0,025	0,025	0,030	0,040	0,050	0,060	0,070	0,075	0,080	0,085	0,090
	P5-P12	120-160	0,025	0,025	0,030	0,035	0,050	0,055	0,060	0,065	0,070	0,075	0,080
	P13	70-130	0,025	0,025	0,030	0,030	0,045	0,045	0,050	0,055	0,060	0,065	0,070
	P14	70-110	0,015	0,015	0,025	0,030	0,045	0,045	0,050	0,055	0,060	0,065	0,070
M	M1	80-120	0,020	0,020	0,025	0,030	0,045	0,045	0,050	0,055	0,060	0,065	0,070
	M2-M3	60-100	0,020	0,020	0,025	0,040	0,045	0,050	0,055	0,060	0,065	0,070	0,075
K	K1-K5	140-200	0,025	0,025	0,030	0,040	0,060	0,060	0,070	0,075	0,080	0,085	0,090
N	N1-N5	240-280	0,035	0,040	0,050	0,050	0,055	0,065	0,075	0,080	0,085	0,090	0,095
	N7-N10	260-300	0,030	0,035	0,045	0,050	0,055	0,060	0,070	0,075	0,080	0,085	0,090
S	S3-S5	30-50	0,010	0,010	0,010	0,015	0,025	0,025	0,040	0,045	0,050	0,055	0,060
	S6-S8	40-70	0,010	0,010	0,015	0,020	0,030	0,030	0,040	0,045	0,050	0,060	0,065

For machining steel and cast iron with hardness up to 45 HRC, stainless steel and difficult to machine materials

MASTERMILL

645

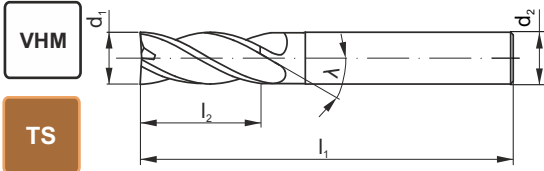
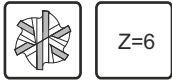

TS



Workpiece material



Shank



Tool material

VHM

Coating

TS

Corner type



d ₁	d ₂ h6	l ₁	l ₂	Z	INDEX
6	6	57	16	6	M9-64GM00-0060
8	8	63	20	6	M9-64GM00-0080
10	10	72	25	6	M9-64GM00-0100
12	12	83	30	6	M9-64GM00-0120
14	14	83	35	6	M9-64GM00-0140
16	16	92	40	6	M9-64GM00-0160
20	20	104	45	6	M9-64GM00-0200





















ISO	V _c [m/min]	d ₁ [mm]							
		6	8	10	12	14	16	20	
		fz [mm]	fz [mm]	fz [mm]	fz [mm]	fz [mm]	fz [mm]	fz [mm]	
P	P1-P4	170-220	0,015	0,020	0,025	0,030	0,035	0,040	0,050
	P5-P12	160-190	0,010	0,020	0,020	0,030	0,030	0,040	0,050
	P13	120-150	0,010	0,010	0,020	0,025	0,030	0,030	0,040
	P14	80-130	0,010	0,010	0,020	0,025	0,030	0,030	0,040
M	M1	100-130	0,010	0,010	0,020	0,025	0,030	0,030	0,040
	M2-M3	70-110	0,015	0,020	0,035	0,040	0,045	0,045	0,055
K	K1-K6	105-135	0,015	0,020	0,025	0,030	0,030	0,035	0,045
N	N1-N5	200-250	0,015	0,020	0,025	0,030	0,035	0,040	0,045
	N7-N10	150-200	0,010	0,010	0,020	0,025	0,030	0,030	0,040
S	S3-S5	40-70	0,015	0,025	0,025	0,040	0,045	0,050	0,060
	S6-S8	60-90	0,020	0,030	0,030	0,040	0,045	0,050	0,065

























Example of order

M9-64GM00-0060
MASTERMILL 645 6x6x16x57 VHM TS

Corner radius and another tool dimensions
available on request

MASTERMILL				X-MILL									Name
440N	R440N	B440N	645	230	230L	B230	B230L	345	R345	440S	R440S		
Z=4	Z=4	Z=4	Z=6	Z=2	Z=2	Z=2	Z=2	Z=3	Z=3	Z=4	Z=4	Number of flutes	
VHM	VHM	VHM	VHM	VHM	VHM	VHM	VHM	VHM	VHM	VHM	VHM	Tool material	
TS	TS	TS	TS	AT	AT	AT	AT	AT	AT	AT	AT	Coating	
												Corner type	
8	8	9	10	14	15	16	17	18	18	19	19	Page	
•	•	•	•	•	•	•	•	•	•	•	•	P1	
•	•	•	•	•	•	•	•	•	•	•	•	P2	
•	•	•	•	•	•	•	•	•	•	•	•	P3	
•	•	•	•	•	•	•	•	•	•	•	•	P4	
•	•	•	•	•	•	•	•	•	•	•	•	P5	
•	•	•	•	•	•	•	•	•	•	•	•	P6	
•	•	•	•	•	•	•	•	•	•	•	•	P7	
•	•	•	•	•	•	•	•	•	•	•	•	P8	
•	•	•	•	•	•	•	•	•	•	•	•	P9	
•	•	•	•	•	•	•	•	•	•	•	•	P10	
•	•	•	•	•	•	•	•	•	•	•	•	P11	
•	•	•	•	•	•	•	•	•	•	•	•	P12	
•	•	•	•	•	•	•	•	•	•	•	•	P13	
•	•	•	•	•	•	•	•	•	•	•	•	P14	
•	•	•	•					○	○	○	○	M1	
•	•	•	•					○	○	○	○	M2	
•	•	•	•					○	○	○	○	M3	
•	•	•	•	•	•	•	•	•	•	•	•	K1	
•	•	•	•	•	•	•	•	•	•	•	•	K2	
•	•	•	•	•	•	•	•	•	•	•	•	K3	
•	•	•	•	•	•	•	•	•	•	•	•	K4	
•	•	•	•	•	•	•	•	•	•	•	•	K5	
•	•	•	•	•	•	•	•	•	•	•	•	K6	
○	○	○	○					○	○	○	○	N1	
○	○	○	○					○	○	○	○	N2	
○	○	○	○					○	○	○	○	N3	
○	○	○	○					○	○	○	○	N4	
○	○	○	○					○	○	○	○	N5	
○	○	○	○	○	○	○	○	○	○	○	○	N6	
○	○	○	○	○	○	○	○	○	○	○	○	N7	
○	○	○	○	○	○	○	○	○	○	○	○	N8	
○	○	○	○	○	○	○	○	○	○	○	○	N9	
○	○	○	○	○	○	○	○	○	○	○	○	N10	
•	•	•	•					○	○	○	○	S1	
•	•	•	•					○	○	○	○	S2	
•	•	•	•					○	○	○	○	S3	
•	•	•	•					○	○	○	○	S4	
•	•	•	•					○	○	○	○	S5	
•	•	•	•					○	○	○	○	S6	
•	•	•	•					○	○	○	○	S7	
•	•	•	•					○	○	○	○	S8	
○	○	○	○									H1	
												H2	
												H3	
												H4	

Name	X-MILL										ZGR
	440N	R440N	440NL	R440NL	430L	R430L	B440	540	R540	420	
											
Number of flutes	Z=4	Z=4	Z=4	Z=4	Z=4	Z=4	Z=4	Z=5	Z=5	Z=3-4	
Tool material	VHM	VHM	VHM	VHM	VHM	VHM	VHM	VHM	VHM	VHM	
Coating	AT	AT	AT	AT	AT	AT	AT	AT	AT	AT	
Corner type											
Page	21	21	22	22	23	23	24	25	25	26	
P	P1	●	●	●	●	●	●	●	●	●	●
	P2	●	●	●	●	●	●	●	●	●	●
	P3	●	●	●	●	●	●	●	●	●	●
	P4	●	●	●	●	●	●	●	●	●	●
	P5	●	●	●	●	●	●	●	●	●	●
	P6	●	●	●	●	●	●	●	●	●	●
	P7	●	●	●	●	●	●	●	●	●	●
	P8	●	●	●	●	●	●	●	●	●	●
	P9	●	●	●	●	●	●	●	●	●	●
	P10	●	●	●	●	●	●	●	●	●	●
	P11	●	●	●	●	●	●	●	●	●	●
	P12	●	●	●	●	●	●	●	●	●	●
	P13	●	●	●	●	●	●	●	●	●	●
	P14	●	●	●	●	●	●	●	●	●	●
M	M1	○	○	○	○		○	○	○	○	○
	M2	○	○	○	○		○	○	○	○	○
	M3	○	○	○	○		○	○	○	○	○
K	K1	●	●	●	●	●	●	●	●	●	○
	K2	●	●	●	●	●	●	●	●	●	○
	K3	●	●	●	●	●	●	●	●	●	○
	K4	●	●	●	●	●	●	●	●	●	○
	K5	●	●	●	●	●	●	●	●	●	○
	K6	●	●	●	●	●	●	●	●	●	○
N	N1	○	○	○	○		○	○	○		
	N2	○	○	○	○		○	○	○		
	N3	○	○	○	○		○	○	○		
	N4	○	○	○	○		○	○	○		
	N5	○	○	○	○		○	○	○		
	N6										
	N7	○	○	○	○	○	○	○	○	○	
	N8	○	○	○	○	○	○	○	○	○	
	N9	○	○	○	○	○	○	○	○	○	
	N10	○	○	○	○		○	○	○	○	
S	S1	○	○	○	○		○	○	○		
	S2	○	○	○	○		○	○	○		
	S3	○	○	○	○		○	○	○		
	S4	○	○	○	○		○	○	○		
	S5	○	○	○	○		○	○	○		
	S6	○	○	○	○		○	○	○		
	S7	○	○	○	○		○	○	○		
	S8	○	○	○	○		○	○	○		
H	H1										●
	H2										○
	H3										
	H4										○

HRC			AL										Name
HFM 200	B415N	R645	130	245	R245	B245	345	R345	345NL	B345NL	445		
													
Z=2	Z=4	Z=6	Z=1	Z=2	Z=2	Z=2	Z=3	Z=3	Z=3	Z=3	Z=4	Number of flutes	
VHM	VHM	VHM	VHM	VHM	VHM	VHM	VHM	VHM	VHM	VHM	VHM	Tool material	
TS	TS	TS	PVD	PVD TB	PVD TB	TB	PVD TB	PVD TB	TB	TB	PVD	Coating	
												Corner type	
30	31	32	36	37-38	37-38	39	40-43	40-43	44	45	46	Page	
○												P1	
○												P2	
○												P3	
○												P4	
●												P5	
○												P6	
●												P7	
●												P8	
●												P9	
○												P10	
●												P11	
●												P12	
○												P13	
●												P14	
												M1	
												M2	
												M3	
●												K1	
●												K2	
●												K3	
●												K4	
●												K5	
●												K6	
			●	●	●	●	●	●	●	●	●	N1	
			●	●	●	●	●	●	●	●	●	N2	
			●	●	●	●	●	●	●	●	●	N3	
			●	●	●	●	●	●	●	●	●	N4	
			●	●	●	●	●	●	●	●	●	N5	
			●	●	●	●	●	●	●	●	●	N6	
			●	●	●	●	●	●	●	●	●	N7	
			●	●	●	●	●	●	●	●	●	N8	
			●	●	●	●	●	●	●	●	●	N9	
			●	●	●	●	●	●	●	●	●	N10	
												S1	
												S2	
												S3	
												S4	
												S5	
												S6	
												S7	
												S8	
●	●	●										H1	
○	●	●										H2	
○	●	●										H3	
○	●	●										H4	



X-MILL



For machining steel and cast iron with hardness up to 35 HRC					X-MILL												
					230												
Z=2 30° VHM AT 																	
Workpiece material																	
Shank																	
Tool material					VHM												
Coating					AT												
Corner type																	
d ₁	d ₂ h6	l ₁	l ₂	Z	INDEX												
1	4	50	3	2	M9-234X00-0010												
1,5	4	50	4	2	M9-234X00-0015												
2	4	50	6	2	M9-234X00-0020												
2,5	4	50	8	2	M9-234X00-0025												
3	4	50	8	2	M9-234X00-0030												
4	4	50	14	2	M9-234X00-0040												
5	6	50	16	2	M9-234X00-0050												
6	6	50	19	2	M9-234X00-0060												
7	8	58	19	2	M9-234X00-0070												
8	8	58	20	2	M9-234X00-0080												
9	10	72	22	2	M9-234X00-0090												
10	10	72	25	2	M9-234X00-0100												
11	12	73	25	2	M9-234X00-0110												
12	12	73	30	2	M9-234X00-0120												
14	14	83	35	2	M9-234X00-0140												
16	16	92	40	2	M9-234X00-0160												
18	18	100	45	2	M9-234X00-0180												
20	20	100	45	2	M9-234X00-0200												
ISO	V _c [m/min]	d ₁ [mm]															
		1	1,5	2	2,5	3	4	5	6-7	8-9	10-11	12	14	16	18	20	
P	P1-P5	70-110	0,002	0,005	0,005	0,010	0,015	0,025	0,035	0,040	0,050	0,070	0,090	0,090	0,110	0,120	0,130
	P6-P12	50-80	0,002	0,004	0,005	0,050	0,010	0,015	0,025	0,030	0,035	0,050	0,060	0,065	0,080	0,085	0,090
	P13-P14	60-90	0,005	0,005	0,007	0,010	0,010	0,010	0,010	0,010	0,015	0,020	0,025	0,030	0,030	0,035	0,035
K	K1-K4	90-110	0,003	0,005	0,010	0,015	0,020	0,030	0,035	0,035	0,040	0,050	0,060	0,065	0,080	0,085	0,090
	K5-K6	80-90	0,003	0,005	0,010	0,015	0,020	0,030	0,035	0,035	0,040	0,050	0,060	0,065	0,080	0,085	0,090
N	N7-N9	150-170	0,005	0,005	0,010	0,010	0,010	0,015	0,015	0,025	0,030	0,035	0,045	0,050	0,055	0,090	0,100

For machining steel and cast iron with hardness up to 35 HRC

X-MILL

230L

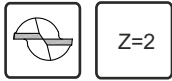

Z=2



30°

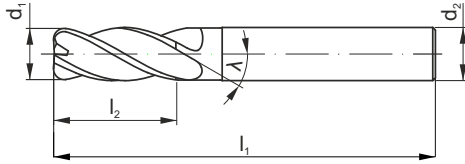

Workpiece material



Shank



Tool material

VHM

Coating

AT

Corner type



d ₁	d ₂ h6	l ₁	l ₂	Z	INDEX
6	6	75	15	2	M9-234X20-0060
6	6	100	15	2	M9-234X20-0060A
8	8	100	20	2	M9-234X20-0080
10	10	100	25	2	M9-234X20-0100
10	10	150	25	2	M9-234X20-0100A
12	12	100	30	2	M9-234X20-0120
12	12	150	30	2	M9-234X20-0120A

ISO	V _c [m/min]	d, [mm]				
		6	8	10	12	
		fz [mm]	fz [mm]	fz [mm]	fz [mm]	
P	P1-P5	60-90	0,030	0,040	0,055	0,065
	P6-P14	50-80	0,010	0,015	0,020	0,025
K	K1-K4	80-100	0,030	0,030	0,040	0,045
	K5-K6	80-90	0,030	0,030	0,040	0,045
N	N7-N9	150-170	0,020	0,025	0,030	0,040

For machining steel and cast iron with hardness up to 35 HRC					X-MILL B230											
Workpiece material																
Shank																
Tool material					VHM											
Coating					AT											
Corner type																
d ₁	d ₂ h6	l ₁	l ₂	Z	INDEX											
1	4	50	2	2	M9-234X0X-0010											
1,5	4	50	3	2	M9-234X0X-0015											
2	4	50	4	2	M9-234X0X-0020											
2,5	4	50	5	2	M9-234X0X-0025											
3	4	50	6	2	M9-234X0X-0030											
4	4	50	8	2	M9-234X0X-0040											
5	6	50	10	2	M9-234X0X-0050											
6	6	50	12	2	M9-234X0X-0060											
8	8	58	16	2	M9-234X0X-0080											
10	1	72	20	2	M9-234X0X-0100											
12	12	73	24	2	M9-234X0X-0120											
16	16	92	32	2	M9-234X0X-0160											
18	18	100	40	2	M9-234X0X-0180											
20	20	100	40	2	M9-234X0X-0200											
ISO	V _c [m/min]	d ₁ [mm]														
		1	1,5	2	2,5	3	4	5	6	8	10	12	16	18	20	
P	P1-P5	70-110	0,002	0,005	0,005	0,010	0,015	0,020	0,035	0,040	0,050	0,070	0,085	0,110	0,120	0,130
	P6-P12	50-80	0,002	0,005	0,005	0,005	0,010	0,015	0,025	0,030	0,035	0,050	0,060	0,080	0,085	0,090
K	K1-K4	90-110	0,003	0,005	0,010	0,015	0,020	0,030	0,035	0,035	0,035	0,050	0,060	0,070	0,075	0,080
	K5-K6	80-90	0,003	0,005	0,010	0,015	0,020	0,030	0,035	0,035	0,035	0,045	0,045	0,055	0,055	0,070
N	N7-N9	150-170	0,005	0,010	0,015	0,025	0,030	0,035	0,040	0,045	0,045	0,050	0,060	0,070	0,080	0,090

For machining steel and cast iron with hardness up to 35 HRC

X-MILL

B230L

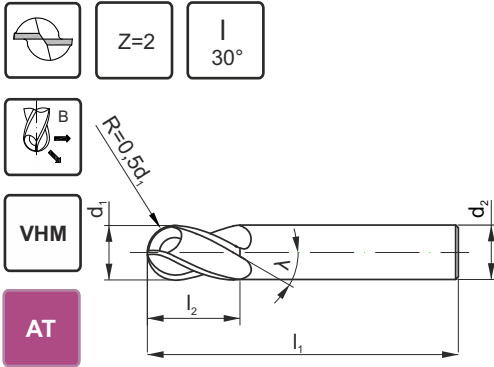

Workpiece material



Shank



Tool material

VHM

Coating

AT

Corner type



d ₁	d ₂ h6	l ₁	l ₂	Z	INDEX
6	6	75	12	2	M9-234X2X-0060
6	6	100	12	2	M9-234X2X-0060A
8	8	100	16	2	M9-234X2X-0080
10	10	100	20	2	M9-234X2X-0100
10	10	150	20	2	M9-234X2X-0100A
12	12	100	24	2	M9-234X2X-0120
12	12	150	24	2	M9-234X2X-0120A
16	16	150	32	2	M9-234X2X-160

ISO	V _c [m/min]	d ₁ [mm]						
		6	8	10	12	14	16	
		fz [mm]	fz [mm]	fz [mm]	fz [mm]	fz [mm]	fz [mm]	
P	P1-P5	70-110	0,040	0,050	0,070	0,085	0,090	0,110
	P6-P12	50-80	0,030	0,035	0,050	0,060	0,065	0,080
K	K1-K4	90-110	0,035	0,035	0,050	0,060	0,065	0,070
	K5-K6	80-90	0,035	0,035	0,045	0,045	0,050	0,055
N	N7-N9	150-170	0,045	0,045	0,050	0,060	0,065	0,070

For machining steel, stainless steel and cast iron with hardness up to 35 HRC							X-MILL			
							345	345	R345	R345
Workpiece material										
Shank										
Tool material							VHM	VHM	VHM	VHM
Coating							AT	AT	AT	AT
Corner type										
d ₁	d ₂ h6	l ₁	l ₂	Z	R	INDEX				
3	6	57	8	3	0,3	M9-344X00-0030	M9-344X00-0030-B	M9-344X0D-0030	M9-344X0D-0030-B	
4	6	57	11	3	0,3	M9-344X00-0040	M9-344X00-0040-B	M9-344X0D-0040	M9-344X0D-0040-B	
5	6	57	13	3	0,3	M9-344X00-0050	M9-344X00-0050-B	M9-344X0D-0050	M9-344X0D-0050-B	
6	6	57	13	3	0,5	M9-344X00-0060	M9-344X00-0060-B	M9-344X01-0060	M9-344X01-0060-B	
8	8	63	19	3	0,5	M9-344X00-0080	M9-344X00-0080-B	M9-344X01-0080	M9-344X01-0080-B	
8	8	63	19	3	1,0	-	-	M9-344X03-0080	M9-344X03-0080-B	
8	8	63	19	3	1,5	-	-	M9-344X04-0080	M9-344X04-0080-B	
10	10	72	22	3	0,5	M9-344X00-0100	M9-344X00-0100-B	M9-344X01-0100	M9-344X01-0100-B	
10	10	72	22	3	2,0	-	-	M9-344X05-0100	M9-344X05-0100-B	
12	12	83	26	3	0,7	M9-344X00-0120	M9-344X00-0120-B	M9-344X02-0120	M9-344X02-0120-B	
12	12	83	26	3	2,0	-	-	M9-344X05-0120	M9-344X05-0120-B	
14	14	83	26	3	0,7	M9-344X00-0140	M9-344X00-0140-B	M9-344X02-0140	M9-344X02-0140-B	
16	16	92	32	3	1,0	M9-344X00-0160	M9-344X00-0160-B	M9-344X03-0160	M9-344X03-0160-B	

ISO	V _c [m/min]	d ₁ [mm]									
		3	4	5	6	8	10	12	14	16	
P	P1-P5	130-160	0,010	0,015	0,025	0,030	0,050	0,060	0,075	0,080	0,085
	P6-P9	80-110	0,010	0,015	0,020	0,025	0,040	0,045	0,055	0,060	0,065
	P10-P12	60-80	0,010	0,015	0,020	0,025	0,040	0,045	0,055	0,060	0,065
	P13	90-140	0,010	0,015	0,020	0,025	0,040	0,045	0,055	0,060	0,065
	P14	90-140	0,005	0,010	0,015	0,020	0,030	0,040	0,045	0,050	0,055
M	M1	90-140	0,010	0,015	0,020	0,025	0,040	0,050	0,060	0,065	0,070
	M2-M3	60-90	0,005	0,010	0,015	0,020	0,030	0,040	0,045	0,050	0,055
K	K1-K6	90-130	0,005	0,010	0,020	0,025	0,040	0,045	0,050	0,055	0,060
N	N1-N5	240-280	0,035	0,040	0,050	0,050	0,055	0,065	0,075	0,080	0,085
	N7-N10	260-300	0,030	0,035	0,045	0,050	0,055	0,060	0,070	0,075	0,080
S	S1,S3	15-25	0,005	0,010	0,015	0,020	0,025	0,035	0,040	0,045	0,050
	S2,S4-S5	10-20	0,005	0,010	0,010	0,015	0,020	0,025	0,030	0,035	0,040
	S6	40-60	0,010	0,015	0,015	0,020	0,025	0,030	0,040	0,045	0,050
	S7-S8	15-20	0,010	0,015	0,015	0,020	0,025	0,030	0,040	0,045	0,050

For machining steel, stainless steel and cast iron with hardness up to 35 HRC							X-MILL			
							440S	440S	R440S	R440S
Z=4 I 35°-39° VHM AT <div style="border: 1px solid black; padding: 5px; display: inline-block;"> Version without corner radius is protected by corner chamfer: for $\varnothing < 6\text{mm}$ $f_1 = 0,1 \times 45^\circ$ for $\varnothing \geq 6\text{mm}$ $f_1 = 0,2 \times 45^\circ$ </div>										
Workpiece material										
Shank										
Tool material							VHM	VHM	VHM	VHM
Coating							AT	AT	AT	AT
Corner type										
d ₁	d ₂ h6	l ₁	l ₂	Z	R	INDEX				
3	6	54	7	4	0,3	M9-444X10-0030	M9-444X10-0030-B	M9-444X1D-0030	M9-444X1D-0030-B	
4	6	54	8	4	0,3	M9-444X10-0040	M9-444X10-0040-B	M9-444X1D-0040	M9-444X1D-0040-B	
5	6	54	10	4	0,3	M9-444X10-0050	M9-444X10-0050-B	M9-444X1D-0050	M9-444X1D-0050-B	
6	6	54	10	4	0,5	M9-444X10-0060	M9-444X10-0060-B	M9-444X11-0060	M9-444X11-0060-B	
8	8	58	12	4	0,5	M9-444X10-0080	M9-444X10-0080-B	M9-444X11-0080	M9-444X11-0080-B	
8	8	58	12	4	1,0	-	-	M9-444X13-0080	M9-444X13-0080-B	
10	10	66	14	4	0,5	M9-444X10-0100	M9-444X10-0100-B	M9-444X11-0100	M9-444X11-0100-B	
10	10	66	14	4	1,0	-	-	M9-444X13-0100	M9-444X13-0100-B	
10	10	66	14	4	1,5	-	-	M9-444X14-0100	M9-444X14-0100-B	
12	12	73	16	4	0,5	M9-444X10-0120	M9-444X10-0120-B	M9-444X11-0120	M9-444X11-0120-B	
12	12	73	16	4	0,7	-	-	M9-444X12-0120	M9-444X12-0120-B	
12	12	73	16	4	1,0	-	-	M9-444X13-0120	M9-444X13-0120-B	
14	14	75	18	4	0,5	M9-444X10-0140	M9-444X10-0140-B	M9-444X11-0140	M9-444X11-0140-B	
16	16	82	22	4	0,5	M9-444X10-0160	M9-444X10-0160-B	M9-444X11-0160	M9-444X11-0160-B	
16	16	82	22	4	1,0	-	-	M9-444X13-0160	M9-444X13-0160-B	
16	16	82	22	4	2,0	-	-	M9-444X15-0160	M9-444X15-0160-B	
20	20	92	26	4	1,0	M9-444X10-0200	M9-444X10-0200-B	M9-444X13-0200	M9-444X13-0200-B	

ISO	Vc [m/min]	d, [mm]										
		3	4	5	6	8	10	12	14	16	20	
		fz [mm]	fz [mm]	fz [mm]	fz [mm]	fz [mm]	fz [mm]	fz [mm]	fz [mm]	fz [mm]	fz [mm]	
P	P1-P7	130-160	0,005	0,010	0,015	0,020	0,030	0,045	0,055	0,060	0,065	0,080
	P8-P13	60-110	0,005	0,010	0,010	0,015	0,025	0,040	0,045	0,050	0,055	0,065
	P14	90-140	0,005	0,005	0,010	0,015	0,020	0,035	0,040	0,045	0,045	0,055
M	M1	90-140	0,005	0,005	0,010	0,015	0,020	0,035	0,040	0,045	0,045	0,055
	M2	60-90	0,005	0,010	0,010	0,015	0,025	0,040	0,045	0,050	0,055	0,065
	M3	60-80	0,005	0,005	0,010	0,015	0,020	0,035	0,040	0,045	0,045	0,055
K	K1-K6	90-130	0,005	0,010	0,020	0,025	0,030	0,040	0,045	0,050	0,055	0,065
N	N1-N5	240-280	0,035	0,040	0,045	0,050	0,055	0,065	0,075	0,080	0,085	0,095
	N7-N10	260-300	0,030	0,035	0,045	0,050	0,055	0,060	0,070	0,075	0,080	0,090
S	S1-S5	15-25	0,005	0,005	0,010	0,020	0,030	0,050	0,055	0,060	0,065	0,080
	S6-S8	40-60	0,005	0,010	0,015	0,020	0,035	0,050	0,055	0,060	0,065	0,080

For machining steel, stainless steel and cast iron with hardness up to 35 HRC									X-MILL					
									440N	440N	R440N	R440N		
<p>Version without corner radius is protected by corner chamfer: for $\varnothing < 6\text{mm}$ $f_1 = 0,1 \times 45^\circ$ for $\varnothing \geq 6\text{mm}$ $f_1 = 0,2 \times 45^\circ$</p>														
Workpiece material														
Shank														
Tool material									VHM	VHM	VHM	VHM		
Coating									AT	AT	AT	AT		
Corner type														
d ₁	d ₂ h6	d ₃	l ₁	l ₂	l ₃	Z	R	INDEX						
1	4	-	50	3	-	4	-	M9-444XA0-0010	-	-	-	-		
1,5	4	-	50	4	-	4	-	M9-444XA0-0015	-	-	-	-		
2,0	4	-	50	6	-	4	-	M9-444XA0-0020	-	-	-	-		
2,5	4	-	50	8	-	4	-	M9-444XA0-0025	-	-	-	-		
3	6	-	57	8	-	4	0,3	M9-444XA0-0030	M9-444XA0-0030-B	M9-444XAD-0030	M9-444XAD-0030-B			
4	6	-	57	11	-	4	0,3	M9-444XA0-0040	M9-444XA0-0040-B	M9-444XAD-0040	M9-444XAD-0040-B			
5	6	-	57	13	-	4	0,3	M9-444XA0-0050	M9-444XA0-0050-B	M9-444XAD-0050	M9-444XAD-0050-B			
6	6	5,5	57	13	21	4	0,5	M9-444XA0-0060	M9-444XA0-0060-B	M9-444XA1-0060	M9-444XA1-0060-B			
6	6	5,5	57	13	21	4	1,0	-	-	M9-444XA3-0060	M9-444XA3-0060-B			
8	8	7,5	63	19	27	4	0,5	M9-444XA0-0080	M9-444XA0-0080-B	M9-444XA1-0080	M9-444XA1-0080-B			
8	8	7,5	63	19	27	4	1,0	-	-	M9-444XA3-0080	M9-444XA3-0080-B			
8	8	7,5	63	19	27	4	2,0	-	-	M9-444XA5-0080	M9-444XA5-0080-B			
10	10	9,2	72	22	32	4	0,5	M9-444XA0-0100	M9-444XA0-0100-B	M9-444XA1-0100	M9-444XA1-0100-B			
10	10	9,2	72	22	32	4	1,0	-	-	M9-444XA3-0100	M9-444XA3-0100-B			
10	10	9,2	72	22	32	4	2,0	-	-	M9-444XA5-0100	M9-444XA5-0100-B			
ISO	V _c [m/min]	d ₁ < 3 mm												
		1	1,5	2	2,5									
P	P1-P5	75	0,004	0,008	0,015	0,015								
	P6-P12	60	0,003	0,006	0,010	0,010								
K	K1-K4	100	0,003	0,006	0,010	0,015								
	K5-K6	85	0,003	0,006	0,020	0,025								
N	N7-N9	170	0,005	0,010	0,015	0,020								
ISO	V _c [m/min]	3	4	5	6	8	10	12	14	16	18	20	25	
		fz [mm]	fz [mm]	fz [mm]	fz [mm]	fz [mm]	fz [mm]	fz [mm]	fz [mm]	fz [mm]	fz [mm]	fz [mm]	fz [mm]	
P	P1-P7	130-160	0,005	0,010	0,015	0,020	0,030	0,045	0,055	0,060	0,065	0,070	0,080	0,095
	P8-P13	60-110	0,005	0,010	0,010	0,015	0,025	0,040	0,045	0,050	0,055	0,060	0,065	0,080
	P14	90-140	0,005	0,005	0,010	0,015	0,020	0,035	0,040	0,045	0,045	0,050	0,055	0,065
M	M1	90-140	0,005	0,005	0,010	0,015	0,020	0,035	0,040	0,045	0,045	0,050	0,055	0,065
	M2	60-90	0,005	0,010	0,010	0,015	0,025	0,040	0,045	0,050	0,055	0,060	0,065	0,080
	M3	60-80	0,005	0,005	0,010	0,015	0,020	0,035	0,040	0,045	0,045	0,050	0,055	0,065
K	K1-K6	90-130	0,005	0,010	0,020	0,025	0,030	0,040	0,045	0,050	0,055	0,060	0,065	0,080
N	N1-N5	240-280	0,035	0,040	0,050	0,050	0,055	0,065	0,075	0,080	0,085	0,090	0,095	0,105
	N7-N10	260-300	0,030	0,035	0,045	0,050	0,055	0,060	0,070	0,075	0,080	0,085	0,090	0,105
S	S1-S5	15-25	0,005	0,005	0,010	0,020	0,030	0,050	0,055	0,060	0,065	0,070	0,080	0,095
	S6-S8	40-60	0,005	0,005	0,015	0,020	0,035	0,050	0,055	0,060	0,065	0,070	0,080	0,095

Example of order

M9-444XA1-0060
X-MILL R440N 6x5,5x6x13x21x57 R0,5 VHM AT

R - for tools with corner radius

Another tool dimensions available on request

For machining steel, stainless steel and cast iron with hardness up to 35 HRC								X-MILL					
								440N	440N	R440N	R440N		
Workpiece material													
Shank													
Tool material								VHM					
Coating								AT					
Corner type													
d ₁	d ₂ h6	d ₃	l ₁	l ₂	l ₃	Z	R	INDEX					
12	12	11	83	26	38	4	0,5	M9-444XA0-0120	M9-444XA0-0120-B	M9-444XA1-0120	M9-444XA1-0120-B		
12	12	11	83	26	38	4	0,7	-	-	M9-444XA2-0120	M9-444XA2-0120-B		
12	12	11	83	26	38	4	1,0	-	-	M9-444XA3-0120	M9-444XA3-0120-B		
12	12	11	83	26	38	4	1,5	-	-	M9-444XA4-0120	M9-444XA4-0120-B		
12	12	11	83	26	38	4	2,0	-	-	M9-444XA5-0120	M9-444XA5-0120-B		
12	12	11	83	26	38	4	3,0	-	-	M9-444XA7-0120	M9-444XA7-0120-B		
14	14	13	83	26	38	4	0,5	M9-444XA0-0140	M9-444XA0-0140-B	M9-444XA1-0140	M9-444XA1-0140-B		
14	14	13	83	26	38	4	0,7	-	-	M9-444XA2-0140	M9-444XA2-0140-B		
14	14	13	83	26	38	4	1,0	-	-	M9-444XA3-0140	M9-444XA3-0140-B		
14	14	13	83	26	38	4	2,0	-	-	M9-444XA5-0140	M9-444XA5-0140-B		
16	16	15	92	32	44	4	0,5	M9-444XA0-0160	M9-444XA0-0160-B	M9-444XA1-0160	M9-444XA1-0160-B		
16	16	15	92	32	44	4	1,0	-	-	M9-444XA3-0160	M9-444XA3-0160-B		
16	16	15	92	32	44	4	2,0	-	-	M9-444XA5-0160	M9-444XA5-0160-B		
16	16	15	92	32	44	4	3,0	-	-	M9-444XA7-0160	M9-444XA7-0160-B		
18	18	17	92	32	44	4	1,0	M9-444XA0-0180	M9-444XA0-0180-B	M9-444XA3-0180	M9-444XA3-0180-B		
20	20	19	104	38	55	4	1,0	M9-444XA0-0200	M9-444XA0-0200-B	M9-444XA3-0200	M9-444XA3-0200-B		
20	20	19	104	45	55	4	1,0	M9-444XA0-0200A	M9-444XA0-0200A-B	M9-444XA3-0200A	M9-444XA3-0200A-B		
20	20	19	104	45	55	4	2,0	-	-	M9-444XA5-0200A	M9-444XA5-0200A-B		
25	25	24	122	55	66	4	1,0	M9-444XA0-0250	M9-444XA0-0250-B	M9-444XA3-0250	M9-444XA3-0250-B		

ISO	V _c [m/min]	d, [mm]												
		3	4	5	6	8	10	12	14	16	18	20	25	
P	P1-P7	130-160	0,005	0,010	0,015	0,020	0,030	0,045	0,055	0,060	0,065	0,070	0,080	0,095
	P8-P13	60-110	0,005	0,010	0,010	0,015	0,025	0,040	0,045	0,050	0,055	0,060	0,065	0,080
	P14	90-140	0,005	0,005	0,010	0,015	0,020	0,035	0,040	0,045	0,045	0,050	0,055	0,065
M	M1	90-140	0,005	0,005	0,010	0,015	0,020	0,035	0,040	0,045	0,045	0,050	0,055	0,065
	M2	60-90	0,005	0,010	0,010	0,015	0,025	0,040	0,045	0,050	0,055	0,060	0,065	0,080
	M3	60-80	0,005	0,005	0,010	0,015	0,020	0,035	0,040	0,045	0,045	0,050	0,055	0,065
K	K1-K6	90-130	0,005	0,010	0,020	0,025	0,030	0,040	0,045	0,050	0,055	0,060	0,065	0,080
N	N1-N5	240-280	0,035	0,040	0,050	0,050	0,055	0,065	0,075	0,080	0,085	0,090	0,095	0,105
	N7-N10	260-300	0,030	0,035	0,045	0,050	0,055	0,060	0,070	0,075	0,080	0,085	0,090	0,105
S	S1-S5	15-25	0,005	0,005	0,010	0,020	0,030	0,050	0,055	0,060	0,065	0,070	0,080	0,095
	S6-S8	40-60	0,005	0,005	0,015	0,020	0,035	0,050	0,055	0,060	0,065	0,070	0,080	0,095

For machining steel, stainless steel and cast iron with hardness up to 35 HRC								X-MILL					
								440NL	440NL	R440NL	R440NL		
<p>Version without corner radius is protected by corner chamfer: for $\varnothing < 6\text{mm}$ $f_1 = 0,1 \times 45^\circ$ for $\varnothing \geq 6\text{mm}$ $f_1 = 0,2 \times 45^\circ$</p> <p>VHM AT</p>													
Workpiece material													
Shank													
Tool material								VHM					
Coating								AT					
Corner type													
d ₁	d ₂ h6	d ₃	l ₁	l ₂	l ₃	Z	R	INDEX					
3	6	2,7	57	7	17	4	0,3	M9-444XG0-0030	M9-444XG0-0030-B	M9-444XGD-0030	M9-444XGD-0030-B		
4	6	3,7	63	8	22	4	0,3	M9-444XG0-0040	M9-444XG0-0040-B	M9-444XGD-0040	M9-444XGD-0040-B		
5	6	4,7	67	10	27	4	0,3	M9-444XG0-0050	M9-444XG0-0050-B	M9-444XGD-0050	M9-444XGD-0050-B		
6	6	5,5	74	10	32	4	0,5	M9-444XG0-0060	M9-444XG0-0060-B	M9-444XG1-0060	M9-444XG1-0060-B		
6	6	5,5	74	10	32	4	1,0	-	-	M9-444XG3-0060	M9-444XG3-0060-B		
8	8	7,5	90	12	46	4	0,5	M9-444XG0-0080	M9-444XG0-0080-B	M9-444XG1-0080	M9-444XG1-0080-B		
8	8	7,5	90	12	46	4	1,0	-	-	M9-444XG3-0080	M9-444XG3-0080-B		
10	10	9,2	102	14	55	4	0,5	M9-444XG0-0100	M9-444XG0-0100-B	M9-444XG1-0100	M9-444XG1-0100-B		
10	10	9,2	102	14	55	4	1,0	-	-	M9-444XG3-0100	M9-444XG3-0100-B		
10	10	9,2	102	14	55	4	2,5	-	-	M9-444XG6-0100	M9-444XG6-0100-B		
12	12	11	117	16	64	4	0,5	M9-444XG0-0120	M9-444XG0-0120-B	M9-444XG1-0120	M9-444XG1-0120-B		
12	12	11	117	16	64	4	1,0	-	-	M9-444XG3-0120	M9-444XG3-0120-B		
16	16	15	141	22	87	4	0,5	M9-444XG0-0160	M9-444XG0-0160-B	M9-444XG1-0160	M9-444XG1-0160-B		
16	16	15	141	22	87	4	1,0	-	-	M9-444XG3-0160	M9-444XG3-0160-B		
16	16	15	141	22	87	4	2,0	-	-	M9-444XG5-0160	M9-444XG5-0160-B		
20	20	19	164	26	110	4	1,0	M9-444XG0-0200	M9-444XG0-0200-B	M9-444XG3-0200	M9-444XG3-0200-B		

ISO	V _c [m/min]	d ₁ [mm]										
		3	4	5	6	8	10	12	14	16	20	
P	P1-P7	130-160	0,005	0,010	0,015	0,020	0,030	0,045	0,055	0,060	0,065	0,080
	P8-P13	60-110	0,005	0,010	0,010	0,015	0,025	0,040	0,045	0,050	0,055	0,065
	P14	90-140	0,005	0,005	0,010	0,015	0,020	0,035	0,040	0,045	0,045	0,055
M	M1	90-140	0,005	0,005	0,010	0,015	0,020	0,035	0,040	0,045	0,045	0,055
	M2	60-90	0,005	0,010	0,010	0,015	0,025	0,040	0,045	0,050	0,055	0,065
	M3	60-80	0,005	0,005	0,010	0,015	0,025	0,035	0,040	0,045	0,045	0,055
K	K1-K6	90-130	0,005	0,010	0,020	0,025	0,030	0,040	0,045	0,050	0,055	0,065
N	N1-N5	240-280	0,035	0,040	0,050	0,050	0,055	0,065	0,075	0,080	0,085	0,095
	N7-N10	260-300	0,030	0,035	0,045	0,050	0,055	0,060	0,070	0,075	0,080	0,090
S	S1-S5	15-25	0,005	0,010	0,015	0,020	0,030	0,050	0,055	0,060	0,065	0,080
	S6-S8	40-60	0,005	0,010	0,015	0,020	0,035	0,050	0,055	0,060	0,650	0,075

For machining steel and cast iron with hardness up to 35 HRC							X-MILL		
							430L	430L	R430L
Workpiece material									
Shank									
Tool material							VHM	VHM	VHM
Coating							AT	AT	AT
Corner type									
d ₁	d ₂ h6	l ₁	l ₂	Z	R	INDEX			
2	4	50	15	4	-	M9-434X20-0020	-	-	
3	4	50	20	4	0,3	M9-434X20-0030	-	M9-434X2D-0050	
4	4	75	25	4	0,3	M9-434X20-0040	-	M9-434X2D-0060	
5	6	75	30	4	0,3	M9-434X20-0050	M9-434X20-0050-B	M9-434X2D-0050	
6	6	75	30	4	0,5	M9-434X20-0060	M9-434X20-0060-B	M9-434X21-0060	
8	8	100	40	4	0,5	M9-434X20-0080	M9-434X20-0080-B	M9-434X21-0080	
10	10	100	40	4	0,5	M9-434X20-0100	M9-434X20-0100-B	M9-434X21-0100	
12	12	100	45	4	0,7	M9-434X20-0120	M9-434X20-0120-B	M9-434X22-0120	
16	16	150	60	4	1,0	M9-434X20-0160	M9-434X20-0160-B	M9-434X23-0160	
20	20	150	60	4	1,0	M9-434X20-0200	M9-434X20-0200-B	M9-434X23-0200	

ISO	V _c [m/min]	d ₁ [mm]										
		2	3	4	5	6	8	10	12	16	20	
		fz [mm]	fz [mm]	fz [mm]	fz [mm]	fz [mm]	fz [mm]	fz [mm]	fz [mm]	fz [mm]	fz [mm]	fz [mm]
P	P1-P5	50-65	0,010	0,015	0,020	0,030	0,040	0,060	0,075	0,085	0,100	0,110
	P6-P12	40-50	0,005	0,010	0,010	0,100	0,010	0,015	0,020	0,020	0,025	0,030
K	K1-K4	60-80	0,005	0,010	0,010	0,015	0,030	0,030	0,040	0,050	0,055	0,060
	K5-K6	50-70	0,005	0,010	0,010	0,015	0,030	0,030	0,040	0,050	0,055	0,060
N	N7-N9	90-140	0,015	0,025	0,030	0,030	0,035	0,040	0,050	0,060	0,075	0,090

For machining steel, stainless steel and cast iron with hardness up to 35 HRC						X-MILL						
						B440						
Workpiece material												
Shank												
Tool material						VHM						
Coating						AT						
Corner type												
d_1	d_2 h6	l_1	l_2	Z	R	INDEX						
3	6	54	7	4	1,5	M9-444X1X-0030						
4	6	54	8	4	2,0	M9-444X1X-0040						
5	6	54	10	4	2,5	M9-444X1X-0050						
6	6	54	10	4	3,0	M9-444X1X-0060						
8	8	58	12	4	4,0	M9-444X1X-0080						
10	10	66	14	4	5,0	M9-444X1X-0100						
12	12	73	16	4	6,0	M9-444X1X-0120						
14	14	75	18	4	7,0	M9-444X1X-0140						
16	16	82	22	4	8,0	M9-444X1X-0160						
18	18	84	24	4	9,0	M9-444X1X-0180						
20	20	92	26	4	10,0	M9-444X1X-0200						

ISO	Vc [m/min]	d_1 [mm]											
		3	4	5	6	8	10	12	14	16	18	20	
		fz [mm]	fz [mm]	fz [mm]	fz [mm]	fz [mm]	fz [mm]	fz [mm]	fz [mm]	fz [mm]	fz [mm]	fz [mm]	fz [mm]
P	P1-P13	80-130	0,025	0,025	0,030	0,040	0,060	0,060	0,070	0,075	0,080	0,085	0,090
	P14	60-70	0,015	0,015	0,025	0,030	0,040	0,045	0,050	0,055	0,060	0,065	0,070
M	M1-M2	80-110	0,020	0,020	0,025	0,040	0,045	0,050	0,055	0,060	0,065	0,070	0,075
K	K1-K6	80-130	0,025	0,025	0,030	0,040	0,060	0,060	0,070	0,075	0,080	0,085	0,090
N	N1-N5	240-280	0,035	0,040	0,050	0,050	0,055	0,065	0,075	0,080	0,085	0,090	0,095
	N7-N10	260-300	0,030	0,035	0,045	0,050	0,055	0,060	0,070	0,075	0,080	0,085	0,090
S	S1-S5	20-30	0,010	0,010	0,010	0,015	0,025	0,025	0,040	0,045	0,050	0,055	0,060
	S6-S8	40-55	0,010	0,010	0,015	0,020	0,030	0,030	0,040	0,045	0,050	0,060	0,065

For machining steel, stainless steel and cast iron with hardness up to 35 HRC						X-MILL			
						540	540	R540	R540
Workpiece material									
Shank									
Tool material						VHM			
Coating						AT			
Corner type									
d ₁	d ₂ h6	l ₁	l ₂	Z	R	INDEX			
6	6	57	13	5	0,5	M9-544X00-0060	M9-544X00-0060-B	M9-544X01-0060	M9-544X01-0060-B
8	8	63	19	5	0,5	M9-544X00-0080	M9-544X00-0080-B	M9-544X01-0080	M9-544X01-0080-B
8	8	63	19	5	1,0	-	-	M9-544X03-0080	M9-544X03-0080-B
8	8	63	19	5	1,5	-	-	M9-544X04-0080	M9-544X04-0080-B
8	8	63	19	5	2,0	-	-	M9-544X05-0080	M9-544X05-0080-B
10	10	72	22	5	0,5	M9-544X00-0100	M9-544X00-0100-B	M9-544X01-0100	M9-544X01-0100-B
10	10	72	22	5	2,5	-	-	M9-544X06-0100	M9-544X06-0100-B
12	12	83	26	5	0,5	M9-544X00-0120	M9-544X00-0120-B	M9-544X01-0120	M9-544X01-0120-B
12	12	83	26	5	0,7	-	-	M9-544X02-0120	M9-544X02-0120-B
12	12	83	26	5	1,0	-	-	M9-544X03-0120	M9-544X03-0120-B
14	14	83	26	5	0,5	M9-544X00-0140	M9-544X00-0140-B	M9-544X01-0140	M9-544X01-0140-B
16	16	92	32	5	0,5	M9-544X00-0160	M9-544X00-0160-B	M9-544X01-0160	M9-544X01-0160-B
16	16	92	32	5	1,0	-	-	M9-544X03-0160	M9-544X03-0160-B
16	16	92	32	5	2,0	-	-	M9-544X05-0160	M9-544X05-0160-B
18	18	92	32	5	1,0	M9-544X00-0180	M9-544X00-0180-B	M9-544X03-0180	M9-544X03-0180-B
20	20	104	38	5	1,0	M9-544X00-0200	M9-544X00-0200-B	M9-544X03-0200	M9-544X03-0200-B

ISO	V _c [m/min]	d, [mm]								
		6	8	10	12	14	16	18	20	
P	P1-P13	130-150	0,035	0,040	0,050	0,065	0,070	0,075	0,080	0,090
	P14	90-100	0,030	0,035	0,040	0,045	0,065	0,070	0,070	0,075
M	M1-M2	90-120	0,030	0,035	0,040	0,045	0,065	0,070	0,070	0,075
K	K1-K6	110-140	0,035	0,040	0,050	0,065	0,070	0,075	0,075	0,090
N	N1-N5	240-280	0,050	0,055	0,065	0,075	0,080	0,085	0,085	0,095
	N7-N10	260-300	0,050	0,055	0,060	0,070	0,075	0,080	0,085	0,090
S	S1-S5	20-30	0,015	0,020	0,025	0,035	0,045	0,050	0,050	0,060
	S6-S8	40-65	0,030	0,035	0,040	0,050	0,055	0,065	0,065	0,075

For roughing steel, cast iron, difficult to machine materials and non-ferrous materials					ZGR					
					420	420				
<div style="display: flex; flex-direction: column; align-items: flex-start;"> <div style="display: flex; gap: 10px;"> <div style="border: 1px solid black; padding: 2px;">Typ HR</div> <div style="border: 1px solid black; padding: 2px;">Z=3-4</div> </div> <div style="display: flex; gap: 10px; margin-top: 5px;"> <div style="border: 1px solid black; padding: 2px;"></div> <div style="border: 1px solid black; padding: 2px;"> 20°</div> </div> <div style="display: flex; align-items: center; margin-top: 5px;"> <div style="border: 1px solid black; padding: 2px; margin-right: 10px;">VHM</div> </div> <div style="margin-top: 5px; background-color: #800040; color: white; padding: 2px 5px;">AT</div> </div>										
Workpiece material										
Shank										
Tool material					VHM		VHM			
Coating					AT		AT			
Corner type										
d ₁	d ₂ h6	l ₁	l ₂	Z	INDEX					
6	6	57	16	3	M9-424A00-0060	M9-424A00-0060-B				
7	8	63	16	3	M9-424A00-0070	M9-424A00-0070-B				
8	8	63	16	3	M9-424A00-0080	M9-424A00-0080-B				
9	10	72	19	4	M9-424A00-0090	M9-424A00-0090-B				
10	10	72	22	4	M9-424A00-0100	M9-424A00-0100-B				
12	12	83	26	4	M9-424A00-0120	M9-424A00-0120-B				
14	14	83	26	4	M9-424A00-0140	M9-424A00-0140-B				
16	16	92	32	4	M9-424A00-0160	M9-424A00-0160-B				
18	18	92	32	4	M9-424A00-0180	M9-424A00-0180-B				
20	20	104	38	4	M9-424A00-0200	M9-424A00-0200-B				
ISO	V _c [m/min]	d ₁ [mm]								
		6	8	10	12	14	16	18	20	
		fz [mm]	fz [mm]	fz [mm]	fz [mm]	fz [mm]	fz [mm]	fz [mm]	fz [mm]	fz [mm]
P	P1-P2	100-140	0,030	0,035	0,035	0,045	0,050	0,055	0,060	0,070
	P9-P11	100-120	0,025	0,030	0,030	0,035	0,040	0,045	0,045	0,050
	P13-P14	50-65	0,015	0,020	0,020	0,025	0,030	0,035	0,035	0,040
M	M1-M2	40-60	0,015	0,020	0,020	0,025	0,030	0,035	0,035	0,040
K	K1-K2	110-160	0,030	0,035	0,045	0,050	0,055	0,056	0,060	0,070
	K3-K6	80-110	0,020	0,020	0,035	0,035	0,040	0,040	0,045	0,050
H	H1,H2,H4	50-90	0,020	0,020	0,035	0,030	0,035	0,035	0,040	0,040

HRC



For high feed machining materials with hardness up to 55 HRC							HRC HFM 200				
Workpiece material											
Shank											
Tool material							VHM				
Coating							AD				
Corner type											
d_1	d_2 h6	l_1	$a_{p_{max}}$	l_3	Z	R	INDEX				
6	6	57	0,30	20	2	0,6	M9-20E9A0-0060				
8	8	63	0,35	20	2	0,8	M9-20E9A0-0080				
10	10	72	0,40	30	2	1,0	M9-20E9A0-0100				
12	12	83	0,70	35	2	1,2	M9-20E9A0-0120				
16	16	92	0,80	50	2	1,6	M9-20E9A0-0160				
ISO	V_c [m/min]	a_e [mm]	d_1 [mm]								
			6	8	10	12	16				
			f_z [mm]	f_z [mm]	f_z [mm]	f_z [mm]	f_z [mm]				
P	P1-P5	300-350	0,4 - 0,6xD	0,4	0,5	0,6	0,8	1,2			
	P6-P14	200-250	0,4 - 0,6xD	0,3	0,4	0,5	0,6	1,0			
K	K1-K3	400-450	0,4 - 0,6xD	0,4	0,5	0,6	0,8	1,2			
	K4-K6	300-350	0,4 - 0,6xD	0,3	0,4	0,5	0,6	1,0			
H	H1,H2,H4	70-120	0,2 - 0,4xD	0,3	0,4	0,5	0,6	1,0			

H - group materials may only be machined dry. For more information see chapter 3.4. in Technical Information.

For hardened materials								HRC			
								B415N			
Workpiece material											
Shank											
Tool material								VHM			
Coating								TS			
Corner type											
d_1	d_2 h6	d_3	l_1	l_2	l_3	Z	R	INDEX			
3	6	2,9	57	7	21	4	1,5	M9-41G9AX-0030			
4	6	3,9	57	8	21	4	2,0	M9-41G9AX-0040			
5	6	4,9	57	10	21	4	2,5	M9-41G9AX-0050			
6	6	5,9	57	10	21	4	3,0	M9-41G9AX-0060			
8	8	7,8	63	12	23	4	4,0	M9-41G9AX-0080			
10	10	9,8	72	14	27	4	5,0	M9-41G9AX-0100			
12	12	11,8	75	16	30	4	6,0	M9-41G9AX-0120			
16	16	15,8	92	22	44	4	8,0	M9-41G9AX-0160			
ISO	Vc [m/min]	d, [mm]									
		3	4	5	6	8	10	12	16		
H	H1	180-220	fz [mm]	fz [mm]	fz [mm]	fz [mm]	fz [mm]	fz [mm]	fz [mm]	fz [mm]	
	H2, H4	140-180	0,040	0,055	0,070	0,085	0,100	0,120	0,160	0,220	
	H3	115-160	0,030	0,035	0,055	0,065	0,080	0,100	0,150	0,175	
			0,025	0,035	0,045	0,055	0,065	0,085	0,100	0,150	

H - group materials may only be machined dry. For more information see chapter 3.4. in Technical Information.

For hardened materials						HRC				
						R645				
Z=6 $\lambda = 45^\circ$ VHM TS 										
Workpiece material										
Shank										
Tool material						VHM				
Coating						TS				
Corner type										
d_1	d_2 h6	l_1	l_2	Z	R	INDEX				
6	6	57	13	6	0,5	M9-64G901-0060				
8	8	63	19	6	0,5	M9-64G901-0080				
10	10	72	22	6	1,0	M9-64G903-0100				
12	12	75	26	6	1,0	M9-64G903-0120				
16	16	92	32	6	1,5	M9-64G904-0160				
ISO	V_c [m/min]	d_1 [mm]								
		6	8	10	12	16				
		f_z [mm]	f_z [mm]	f_z [mm]	f_z [mm]	f_z [mm]				
H	H1	80-140	0,035	0,050	0,060	0,070	0,085			
	H2-H4	50-80	0,025	0,035	0,045	0,050	0,065			

H - group materials may only be machined dry. For more information see chapter 3.4. in Technical Information.

AL



For machining aluminium alloys and other non-ferrous materials					AL									
					130									
Workpiece material					<table border="1"> <tr><td>P</td><td>M</td><td>K</td></tr> <tr><td>N</td><td>S</td><td>H</td></tr> </table>				P	M	K	N	S	H
P	M	K												
N	S	H												
Shank														
Tool material					VHM									
Coating					-									
Corner type														
					INDEX									
d_1	d_2	l_1	l_2	Z										
3	6	57	12	1	M9-131700-0030									
4	6	57	12	1	M9-131700-0040									
5	6	57	14	1	M9-131700-0050									
6	6	57	16	1	M9-131700-0060									
8	8	63	20	1	M9-131700-0080									
10	10	72	22	1	M9-131700-0100									
ISO		V_c [m/min]	d_1 [mm]											
			3	4	5	6	8	10						
N	N1-N2	250-400	fz [mm]	fz [mm]	fz [mm]	fz [mm]	fz [mm]	fz [mm]						
	N3-N5	290-440	0,010	0,015	0,020	0,025	0,030	0,035						
	N7-N9	210-360	0,005	0,010	0,015	0,020	0,025	0,030						

For machining aluminium alloys and other non-ferrous materials						AL							
						245	245	R245	R245				
Workpiece material													
Shank													
Tool material						VHM							
Coating						-							
Corner type													
d ₁	d ₂	l ₁	l ₂	Z	R	INDEX							
3	3	39	12	2	0,3	M9-241700-0030	-	M9-24170D-0030	-				
4	4	51	12	2	0,3	M9-241700-0040	-	M9-24170D-0040	-				
5	5	51	14	2	0,3	M9-241700-0050	-	M9-24170D-0050	-				
6	6	57	16	2	0,5	M9-241700-0060	M9-241700-0060-B	M9-241701-0060	M9-241701-0060-B				
6	6	57	16	2	1	-	-	M9-241703-0060	M9-241703-0060-B				
8	8	63	20	2	0,5	M9-241700-0080	M9-241700-0080-B	M9-241701-0080	M9-241701-0080-B				
8	8	63	20	2	1	-	-	M9-241703-0080	M9-241703-0080-B				
10	10	72	22	2	0,5	M9-241700-0100	M9-241700-0100-B	M9-241701-0100	M9-241701-0100-B				
12	12	83	32	2	0,5	M9-241700-0120	M9-241700-0120-B	M9-241701-0120	M9-241701-0120-B				
14	14	83	32	2	0,5	M9-241700-0140	M9-241700-0140-B	M9-241701-0140	M9-241701-0140-B				
16	16	92	36	2	0,5	M9-241700-0160	M9-241700-0160-B	M9-241701-0160	M9-241701-0160-B				
18	18	92	45	2	1	M9-241700-0180	M9-241700-0180-B	M9-241703-0180	M9-241703-0180-B				
20	20	104	50	2	1	M9-241700-0200	M9-241700-0200-B	M9-241703-0200	M9-241703-0200-B				
ISO	V _c [m/min]	d ₁ [mm]											
		3	4	5	6	8	10	12	14	16	18	20	
N	N1-N2	180-270	0,035	0,045	0,050	0,060	0,090	0,110	0,135	0,145	0,155	0,180	0,200
	N3-N4	380-480	0,045	0,055	0,065	0,080	0,150	0,160	0,170	0,200	0,230	0,250	0,270
	N7-N9	180-270	0,010	0,015	0,020	0,025	0,030	0,035	0,050	0,050	0,055	0,090	0,100

For machining aluminium alloys and other non-ferrous materials							AL						
							245	245	R245	R245			
Workpiece material													
Shank													
Tool material							VHM						
Coating							TB						
Corner type													
d ₁	d ₂	l ₁	l ₂	Z	R	INDEX							
3	3	39	12	2	0,3	M9-24B700-0030	-	M9-24B70D-0030	-				
4	4	51	12	2	0,3	M9-24B700-0040	-	M9-24B70D-0040	-				
5	5	51	14	2	0,3	M9-24B700-0050	-	M9-24B70D-0050	-				
6	6	57	16	2	0,5	M9-24B700-0060	M9-24B700-0060-B	M9-24B701-0060	M9-24B701-0060-B				
6	6	57	16	2	1	-	-	M9-24B703-0060	M9-24B703-0060-B				
8	8	63	20	2	0,5	M9-24B700-0080	M9-24B700-0080-B	M9-24B701-0080	M9-24B701-0080-B				
8	8	63	20	2	1	-	-	M9-24B703-0080	M9-24B703-0080-B				
10	10	72	22	2	0,5	M9-24B700-0100	M9-24B700-0100-B	M9-24B701-0100	M9-24B701-0100-B				
12	12	83	32	2	0,5	M9-24B700-0120	M9-24B700-0120-B	M9-24B701-0120	M9-24B701-0120-B				
14	14	83	32	2	0,5	M9-24B700-0140	M9-24B700-0140-B	M9-24B701-0140	M9-24B701-0140-B				
16	16	92	36	2	0,5	M9-24B700-0160	M9-24B700-0160-B	M9-24B701-0160	M9-24B701-0160-B				
18	18	92	45	2	1	M9-24B700-0180	M9-24B700-0180-B	M9-24B703-0180	M9-24B703-0180-B				
20	20	104	50	2	1	M9-24B700-0200	M9-24B700-0200-B	M9-24B703-0200	M9-24B703-0200-B				
ISO	V _c [m/min]	d, [mm]											
		3	4	5	6	8	10	12	14	16	18	20	
N	N1-N2	180-270	fz [mm]	fz [mm]	fz [mm]	fz [mm]	fz [mm]	fz [mm]	fz [mm]	fz [mm]	fz [mm]	fz [mm]	fz [mm]
	N3-N4	380-480	0,035	0,045	0,050	0,060	0,090	0,110	0,135	0,145	0,155	0,180	0,200
	N7-N9	180-270	0,045	0,055	0,065	0,080	0,150	0,160	0,170	0,200	0,230	0,250	0,270
			0,010	0,015	0,020	0,025	0,030	0,035	0,050	0,050	0,055	0,090	0,100

For machining aluminium alloys and other non-ferrous materials						AL				
						B245				
Workpiece material										
Shank										
Tool material						VHM				
Coating						TB				
Corner type										
d ₁	d ₂	l ₁	l ₂	Z	R	INDEX				
3	3	39	12	2	1,5	M9-24B70X-0030				
4	4	51	12	2	2	M9-24B70X-0040				
5	5	51	14	2	2,5	M9-24B70X-0050				
6	6	57	16	2	3	M9-24B70X-0060				
8	8	63	20	2	4	M9-24B70X-0080				
10	10	72	22	2	5	M9-24B70X-0100				
12	12	83	32	2	6	M9-24B70X-0120				
16	16	92	36	2	8	M9-24B70X-0160				
ISO	V _c [m/min]	d, [mm]								
		3	4	5	6	8	10	12	16	
N	N1-N4	230-350	fz [mm]	fz [mm]	fz [mm]	fz [mm]	fz [mm]	fz [mm]	fz [mm]	fz [mm]
	N7-N9	130-170	0,030	0,035	0,040	0,050	0,070	0,085	0,110	0,175
			0,007	0,008	0,010	0,015	0,025	0,030	0,040	0,055

For machining aluminium alloys and other non-ferrous materials						AL							
						345	345	R345	R345				
Workpiece material													
Shank													
Tool material						VHM		VHM		VHM		VHM	
Coating						-		-		-		-	
Corner type													
d ₁	d ₂	l ₁	l ₂	Z	R	INDEX							
3	3	39	12	3	0,3	M9-341700-0030	-	M9-34170D-0030	-				
4	4	51	12	3	0,3	M9-341700-0040	-	M9-34170D-0040	-				
5	5	51	14	3	0,3	M9-341700-0050	-	M9-34170D-0050	-				
6	6	57	16	3	0,5	M9-341700-0060	M9-341700-0060-B	M9-341701-0060	M9-341701-0060-B				
6	6	57	16	3	1	-	-	M9-341703-0060	M9-341703-0060-B				
8	8	63	20	3	0,5	M9-341700-0080	M9-341700-0080-B	M9-341701-0080	M9-341701-0080-B				
8	8	63	20	3	1	-	-	M9-341703-0080	M9-341703-0080-B				
8	8	63	20	3	2	-	-	M9-341705-0080	M9-341705-0080-B				
10	10	72	22	3	0,5	M9-341700-0100	M9-341700-0100-B	M9-341701-0100	M9-341701-0100-B				
10	10	72	22	3	1	-	-	M9-341703-0100	M9-341703-0100-B				
10	10	72	22	3	1,5	-	-	M9-341704-0100	M9-341704-0100-B				
10	10	72	22	3	2	-	-	M9-341705-0100	M9-341705-0100-B				
10	10	72	22	3	2,5	-	-	M9-341706-0100	M9-341706-0100-B				
12	12	83	32	3	0,5	M9-341700-0120	M9-341700-0120-B	M9-341701-0120	M9-341701-0120-B				
12	12	83	32	3	1	-	-	M9-341703-0120	M9-341703-0120-B				
12	12	83	32	3	1,5	-	-	M9-341704-0120	M9-341704-0120-B				
12	12	83	32	3	2	-	-	M9-341705-0120	M9-341705-0120-B				
12	12	83	32	3	2,5	-	-	M9-341706-0120	M9-341706-0120-B				
12	12	83	32	3	3	-	-	M9-341707-0120	M9-341707-0120-B				
ISO	V _c [m/min]	d, [mm]											
		3	4	5	6	8	10	12	14	16	18	20	
N	N1-N4	350-450	0,020	0,030	0,055	0,070	0,085	0,100	0,115	0,135	0,150	0,200	0,220
	N7-N9	160-280	0,020	0,030	0,040	0,550	0,070	0,090	0,095	0,105	0,120	0,140	0,150

For machining aluminium alloys and other non-ferrous materials							AL						
							345	345	R345	R345			
Workpiece material													
Shank													
Tool material							VHM	VHM	VHM	VHM			
Coating							-	-	-	-			
Corner type													
d ₁	d ₂	l ₁	l ₂	Z	R	INDEX							
14	14	83	32	3	0,5	M9-341700-0140	M9-341700-0140-B	M9-341701-0140	M9-341701-0140-B				
14	14	83	32	3	1	-	-	M9-341703-0140	M9-341703-0140-B				
16	16	92	36	3	0,5	M9-341700-0160	M9-341700-0160-B	M9-341701-0160	M9-341701-0160-B				
16	16	92	36	3	1	-	-	M9-341703-0160	M9-341703-0160-B				
16	16	92	36	3	2	-	-	M9-341705-0160	M9-341705-0160-B				
16	16	92	36	3	2,5	-	-	M9-341706-0160	M9-341706-0160-B				
16	16	92	36	3	3	-	-	M9-341707-0160	M9-341707-0160-B				
18	18	92	45	3	1	M9-341700-0180	M9-341700-0180-B	M9-341703-0180	M9-341703-0180-B				
20	20	104	50	3	1	M9-341700-0200	M9-341700-0200-B	M9-341703-0200	M9-341703-0200-B				
20	20	104	50	3	2	-	-	M9-341705-0200	M9-341705-0200-B				
20	20	104	50	3	3	-	-	M9-341707-0200	M9-341707-0200-B				
20	20	104	50	3	4	-	-	M9-341708-0200	M9-341708-0200-B				
ISO	V _c [m/min]	d ₁ [mm]											
		3	4	5	6	8	10	12	14	16	18	20	
N	N1-N4	350-450	0,020	0,030	0,054	0,069	0,085	0,100	0,115	0,135	0,150	0,200	0,220
	N7-N9	160-280	0,020	0,030	0,040	0,055	0,070	0,090	0,095	0,105	0,120	0,140	0,150

For machining aluminium alloys and other non-ferrous materials						AL							
						345	345	R345	R345				
Workpiece material													
Shank													
Tool material						VHM		VHM		VHM		VHM	
Coating						TB		TB		TB		TB	
Corner type													
d ₁	d ₂	l ₁	l ₂	Z	R	INDEX							
3	3	39	12	3	0,3	M9-34B700-0030	-	M9-34B70D-0030	-				
4	4	51	12	3	0,3	M9-34B700-0040	-	M9-34B70D-0040	-				
5	5	51	14	3	0,3	M9-34B700-0050	-	M9-34B70D-0050	-				
6	6	57	16	3	0,5	M9-34B700-0060	M9-34B700-0060-B	M9-34B701-0060	M9-34B701-0060-B				
6	6	57	16	3	1	-	-	M9-34B703-0060	M9-34B703-0060-B				
8	8	63	20	3	0,5	M9-34B700-0080	M9-34B700-0080-B	M9-34B701-0080	M9-34B701-0080-B				
8	8	63	20	3	1	-	-	M9-34B703-0080	M9-34B703-0080-B				
8	8	63	20	3	2	-	-	M9-34B705-0080	M9-34B705-0080-B				
10	10	72	22	3	0,5	M9-34B700-0100	M9-34B700-0100-B	M9-34B701-0100	M9-34B701-0100-B				
10	10	72	22	3	1	-	-	M9-34B703-0100	M9-34B703-0100-B				
10	10	72	22	3	1,5	-	-	M9-34B704-0100	M9-34B704-0100-B				
10	10	72	22	3	2	-	-	M9-34B705-0100	M9-34B705-0100-B				
10	10	72	22	3	2,5	-	-	M9-34B706-0100	M9-34B706-0100-B				
12	12	83	32	3	0,5	M9-34B700-0120	M9-34B700-0120-B	M9-34B701-0120	M9-34B701-0120-B				
12	12	83	32	3	1	-	-	M9-34B703-0120	M9-34B703-0120-B				
12	12	83	32	3	1,5	-	-	M9-34B704-0120	M9-34B704-0120-B				
12	12	83	32	3	2	-	-	M9-34B705-0120	M9-34B705-0120-B				
12	12	83	32	3	2,5	-	-	M9-34B706-0120	M9-34B706-0120-B				
12	12	83	32	3	3	-	-	M9-34B707-0120	M9-34B707-0120-B				
ISO	V _c [m/min]	d, [mm]											
		3	4	5	6	8	10	12	14	16	18	20	
N	N1-N4	350-450	fz [mm]	fz [mm]	fz [mm]	fz [mm]	fz [mm]	fz [mm]	fz [mm]	fz [mm]	fz [mm]	fz [mm]	fz [mm]
	N7-N9	160-280	0,020	0,030	0,054	0,069	0,085	0,100	0,115	0,135	0,150	0,200	0,220
			0,020	0,030	0,040	0,055	0,070	0,090	0,095	0,105	0,120	0,140	0,150

For machining aluminium alloys and other non-ferrous materials							AL						
							345	345	R345	R345			
Workpiece material													
Shank													
Tool material							VHM	VHM	VHM	VHM			
Coating							TB	TB	TB	TB			
Corner type													
d ₁	d ₂	l ₁	l ₂	Z	R	INDEX							
14	14	83	32	3	0,5	M9-34B700-0140	M9-34B700-0140-B	M9-34B701-0140	M9-34B701-0140-B				
14	14	83	32	3	1	-	-	M9-34B703-0140	M9-34B703-0140-B				
16	16	92	36	3	0,5	M9-34B700-0160	M9-34B700-0160-B	M9-34B701-0160	M9-34B701-0160-B				
16	16	92	36	3	1	-	-	M9-34B703-0160	M9-34B703-0160-B				
16	16	92	36	3	2	-	-	M9-34B705-0160	M9-34B705-0160-B				
16	16	92	36	3	2,5	-	-	M9-34B706-0160	M9-34B706-0160-B				
16	16	92	36	3	3	-	-	M9-34B707-0160	M9-34B707-0160-B				
18	18	92	45	3	1	M9-34B700-0180	M9-34B700-0180-B	M9-34B703-0180	M9-34B703-0180-B				
20	20	104	50	3	1	M9-34B700-0200	M9-34B700-0200-B	M9-34B703-0200	M9-34B703-0200-B				
20	20	104	50	3	2	-	-	M9-34B705-0200	M9-34B705-0200-B				
20	20	104	50	3	3	-	-	M9-34B707-0200	M9-34B707-0200-B				
20	20	104	50	3	4	-	-	M9-34B708-0200	M9-34B708-0200-B				
ISO	V _c [m/min]	d ₁ [mm]											
		3	4	5	6	8	10	12	14	16	18	20	
N	N1-N4	350-450	0,020	0,030	0,054	0,069	0,085	0,100	0,115	0,135	0,150	0,200	0,220
	N7-N9	160-280	0,020	0,030	0,040	0,055	0,070	0,090	0,095	0,105	0,120	0,140	0,150

For machining aluminium alloys and other non-ferrous materials							AL						
							345NL						
Z=3 I=45° VHM TB 													
Workpiece material													
Shank													
Tool material							VHM						
Coating							TB						
Corner type													
d_1	d_2 h6	d_3	l_1	l_2	l_3	Z	INDEX						
3	6	2,7	57	7	17	3	M9-34B7A0-0030						
4	6	3,7	63	8	22	3	M9-34B7A0-0040						
5	6	4,7	67	10	27	3	M9-34B7A0-0050						
6	6	5,5	74	10	32	3	M9-34B7A0-0060						
8	8	7,5	90	12	46	3	M9-34B7A0-0080						
10	10	9,2	102	14	55	3	M9-34B7A0-0100						
12	12	11	117	16	64	3	M9-34B7A0-0120						
16	16	15	141	22	87	3	M9-34B7A0-0160						
ISO	Vc [m/min]	d, [mm]											
		3	4	5	6	8	10	12	14	16	18	20	
N	N1-N4	150-250	0,020	0,030	0,055	0,070	0,085	0,100	0,115	0,135	0,150	0,200	0,220
	N7-N9	100-200	0,020	0,030	0,040	0,550	0,070	0,090	0,100	0,105	0,120	0,140	0,150

For machining aluminium alloys and other non-ferrous materials

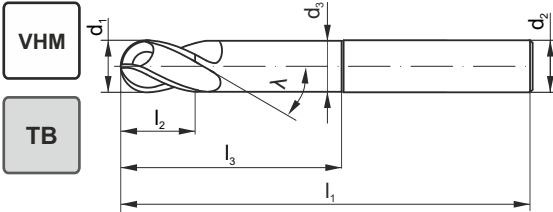
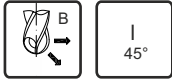
AL
B345NL

VHM
TB

Workpiece material



Shank



Tool material

VHM

Coating

TB

Corner type



d_1	d_2 h6	d_3	l_1	l_2	l_3	Z	R	INDEX
3	6	2,7	57	7	17	3	1,5	M9-34B7AX-0030
4	6	3,7	63	8	22	3	2	M9-34B7AX-0040
5	6	4,7	67	10	27	3	2,5	M9-34B7AX-0050
6	6	5,5	74	10	32	3	3	M9-34B7AX-0060
8	8	7,5	90	12	46	3	4	M9-34B7AX-0080
10	10	9,2	102	14	55	3	5	M9-34B7AX-0100
12	12	11	117	16	64	3	6	M9-34B7AX-0120
16	16	15	141	22	87	3	8	M9-34B7AX-0160

ISO	Vc [m/min]	d, [mm]									
		3	4	5	6	8	10	12	14	16	
		fz [mm]	fz [mm]	fz [mm]	fz [mm]	fz [mm]	fz [mm]	fz [mm]	fz [mm]	fz [mm]	
N	N1-N4	150-250	0,020	0,030	0,055	0,070	0,085	0,100	0,115	0,135	0,150
	N7-N9	100-200	0,020	0,030	0,040	0,550	0,070	0,090	0,100	0,105	0,120

For machining aluminium alloys and other non-ferrous materials					AL								
					445	445							
Z=4 λ 45° VHM PVD 													
Workpiece material													
Shank													
Tool material					VHM								
Coating					-								
Corner type													
d ₁	d ₂	l ₁	l ₂	Z	INDEX								
3	3	39	12	4	M9-441700-0030	-							
4	4	51	12	4	M9-441700-0040	-							
5	5	51	15	4	M9-441700-0050	-							
6	6	57	18	4	M9-441700-0060	M9-441700-0060-B							
8	8	63	24	4	M9-441700-0080	M9-441700-0080-B							
10	10	72	30	4	M9-441700-0100	M9-441700-0100-B							
12	12	83	36	4	M9-441700-0120	M9-441700-0120-B							
14	14	83	42	4	M9-441700-0140	M9-441700-0140-B							
16	16	92	48	4	M9-441700-0160	M9-441700-0160-B							
18	18	92	54	4	M9-441700-0180	M9-441700-0180-B							
20	20	104	60	4	M9-441700-0200	M9-441700-0200-B							
ISO	V _c [m/min]	d ₁ [mm]											
		3	4	5	6	8	10	12	14	16	18	20	
N	N1-N4	270-400	0,025	0,035	0,045	0,055	0,060	0,065	0,070	0,075	0,080	0,090	0,110
	N7-N9	130-250	0,020	0,030	0,035	0,040	0,045	0,050	0,055	0,060	0,075	0,085	0,090

Technical Information

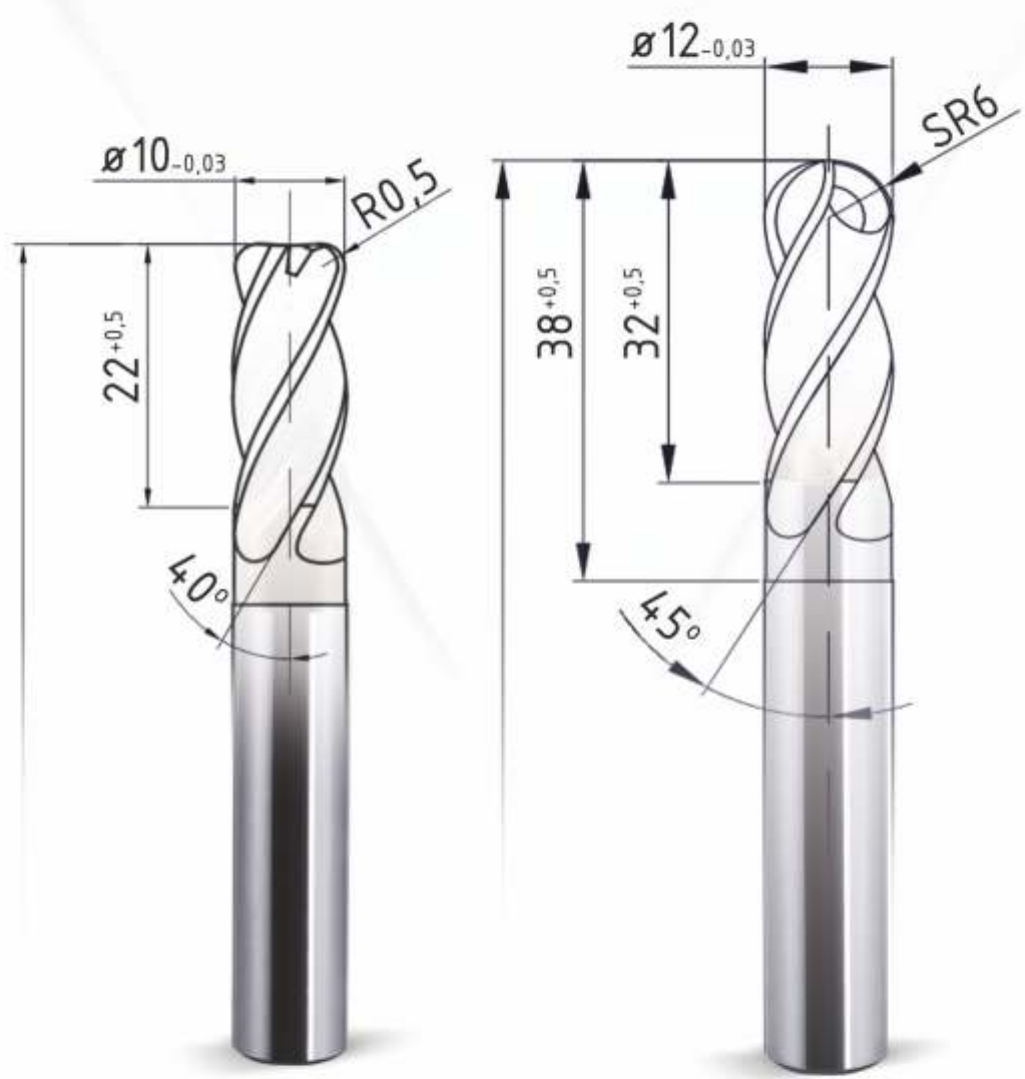

1. End mills

1.1. End mill construction elements

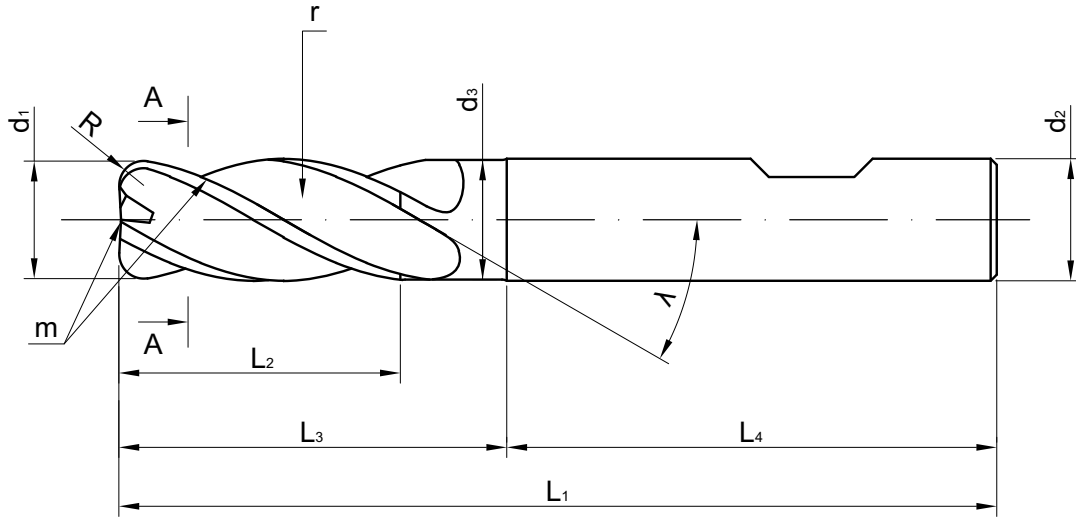

A-A

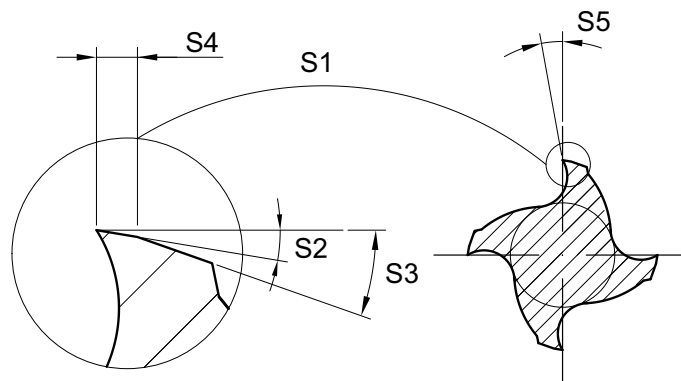

L1 - overall length
 L2 - length of cut
 L3 - reach length
 L4 - shank length
 d1 - working part diameter
 d2 - shank diameter
 d3 - neck diameter
 r - chip flute

λ - helix angle
 R - corner radius
 S1 - relief
 S2 - I relief angle
 S3 - II relief angle
 S4 - width of I relief
 S5 - rake angle
 m - cutting edges

1.2. PVD coatings

TS COATING

Coating	TiAlN + TiAlSiN
Structure	Nanocomposite
Hardness	3800 HV _{0,05}
Max. working temp	1100°C
Coefficient of friction	0,15
Color of coating	coppery 

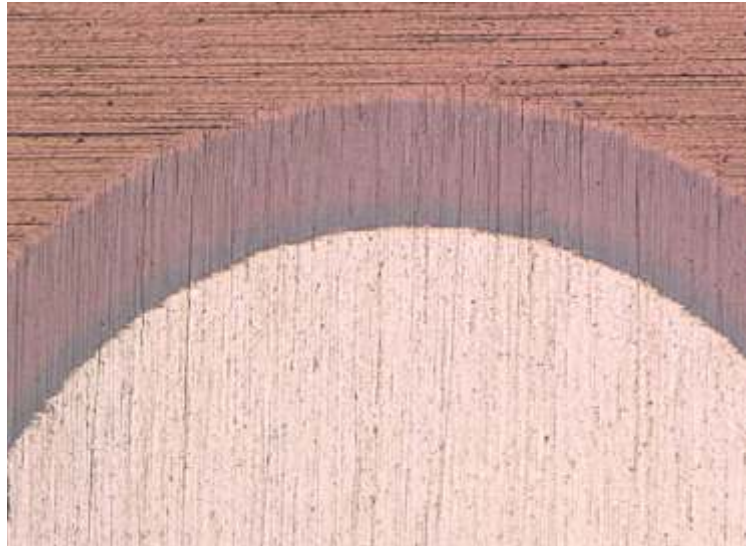

Due to silicon content in TiAlN coating, TS has multilayer nanocomposite structure. TS is being produced in the newest HiPIMS technology which ensures mechanical properties unreachable for other methods. Coatings produced in HiPIMS technology are characterized by the highest cracking resistant. Composition and coating technology causes that new TS coating works very well both in traditional materials from P, K ISO groups and in difficult to machine M, S groups.

TB COATING

Coating	TiB ₂
Structure	Monolayer
Hardness	4000 HV _{0,05}
Max. working temp	900°C
Color of coating	Silver 



The material of coating, the TiB₂ (titanium diboride), is a ceramic material with outstanding properties with regard to its hardness and resistance to abrasion. With its carefully prepared composition (no affinity with aluminum), the material provides high chemical stability and prevents the processed material buildup on cutting edges. The droplless method of manufacturing the coating allows to obtain a very smooth finish, which in turn translates into a very good quality the workpieces' surfaces. The coating is designed for processing materials from the Group N, mainly aluminum alloys (Si<12%) and unalloyed titanium.

AT COATING

Coating	AlTiN
Structure	Gradient
Hardness	3700 HV _{0,05}
Max. working temp	900°C
Coefficient of friction	0,3
Color of coating	Purplish-Grey

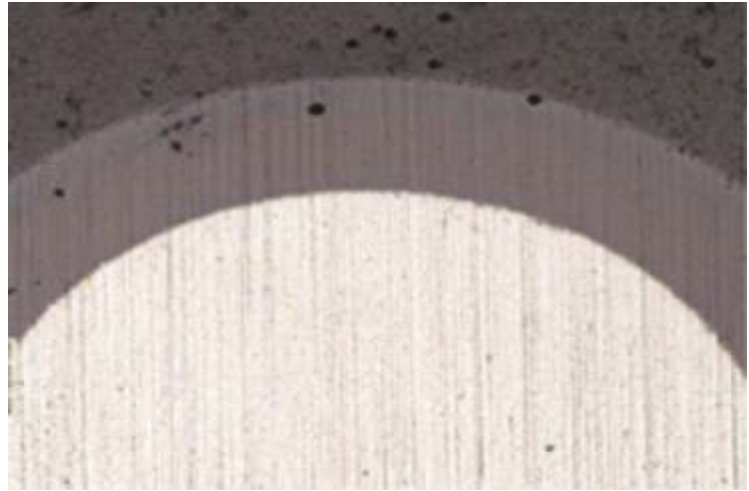

The AT Coating, with the increased Aluminum (Al) content, features high hardness and temperature resistance. The released from the coating, during processing, aluminum oxides serve as additional lubrication of a tool, and at the same they create a thermal barrier, preventing the coating from being worn out, even in the most extreme conditions. Chemical composition and the nanogradient structure ensure high hardness of the coating. As a result, the high resistance to abrasion is achieved, which directly translates into the tool's longer life. The coating may be used for tools exposed to high temperatures, and is suitable for work both, with coolant and without it. The coating is designed for processing materials from the Groups P, M, K, N, S.

1.3. Corner variants

Sharp corner		
Ball nose	Corner radius	Corner chamfer

1.4. Neck

Neck of milling cutter is designed for extension working part of a tool. The table below shows a difference between end mills with and without neck.

	1st pass	2nd pass
With neck		
Without neck		

1.5. Flutes number

Low number of flutes		<ul style="list-style-type: none"> • Bigger capacity of flutes • Possibility of working with a larger width a_e • Easier chip evacuation
More flutes		<ul style="list-style-type: none"> • Larger core • Greater rigidity of the tool • Better surface quality • Higher feed values

1.6. Helix angle

Smaller helix angle	<p>10°</p>	<ul style="list-style-type: none"> • Lower risk of pulling out of the holder • Higher risk of vibrations
	<p>30°</p>	
Bigger helix angle	<p>45°</p>	<ul style="list-style-type: none"> • More teeth in workpiece in the same time • Longer cutting edges • Less vibration • Better surface quality
	<p>60°</p>	

1.7. Variable helix angle and pitch

Unequal helix angle and pitch		<ul style="list-style-type: none"> • Cause that intervals between peaks of cutting forces are irregular • Reduce vibrations • Increase tool life • Allow to work with high cutting speeds.
-------------------------------	--	--

1.8. Shank types

Diameter	Cylindrical- Form HA	Weldon shank - Form HB
Ø6 - Ø20		
Ø25 - Ø32		

2. Designation and application

2.1. Tool groups according to application

<p>MASTERMILL</p> <p>P M K N S</p>	<p>High performance end mills dedicated to work on machining centers, for machining steel, stainless steel up to 45 HRC, cast iron and difficult to machine materials based on titanium and nickel.</p>
<p>X-MILL</p> <p>P M K</p>	<p>General purpose end mills for machining materials with hardness up to 35 HRC.</p>
<p>AL</p> <p>N</p>	<p>Group of tools with cutting geometry optimized to machining non-ferrous materials. Polished flutes and TB coating allow high performance machining of aluminium and copper alloys.</p>
<p>HRC</p> <p>H</p>	<p>End mills produced of comented carbide grade with nano-grain size (0,2 µm), dedicated for machining materials in hardened condition. Optimized geometry and TS coating allow machining materials with higher hardness than 65 HRC.</p>

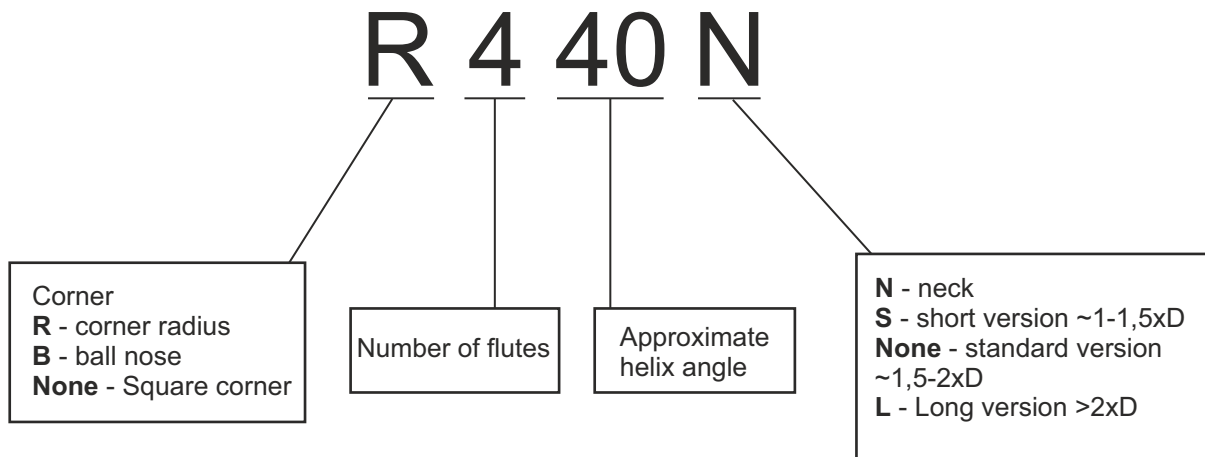

2.2. Designation

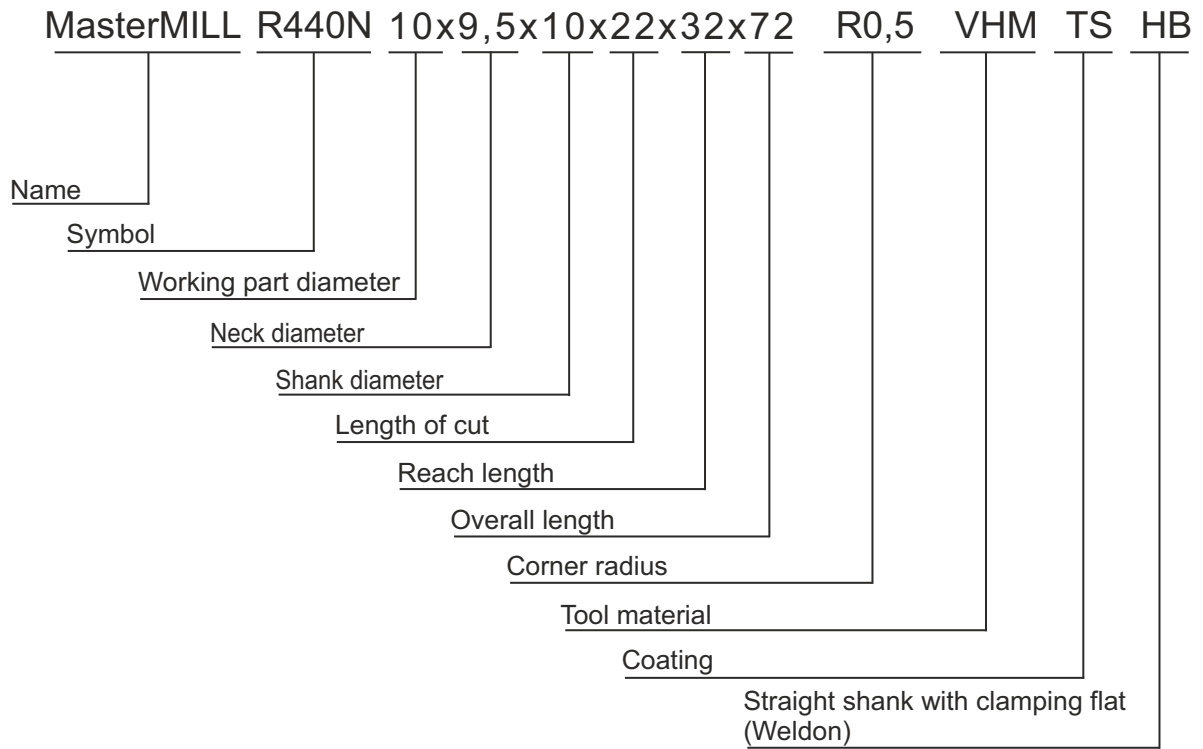

2.3. Marking

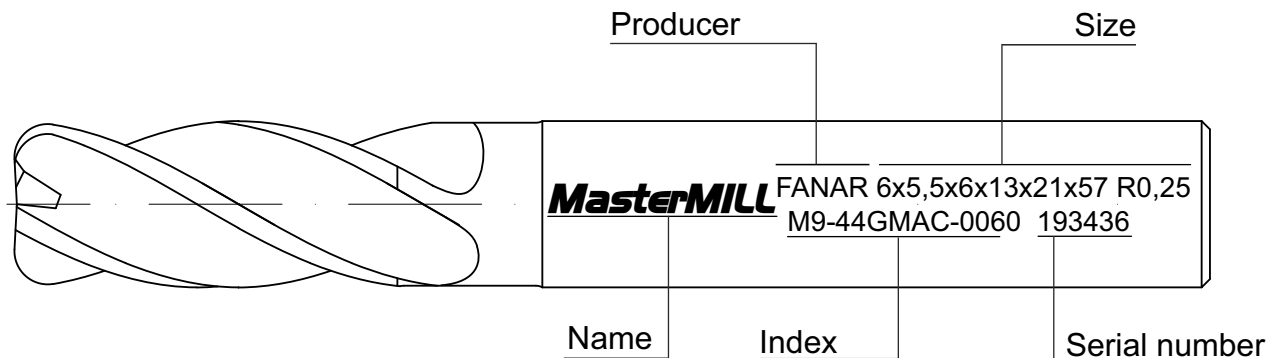

3. Technological recommendations for milling

3.1. Effective milling is the result of:

- technical condition of the machine
- the proper selection of the end mills
- the selection of a precise and rigid holder
- rigid and securely fixation of work piece
- choice of coolant
- machine processing strategy

3.2. Correct tool selection

Milling cutter should be selected from selection table according to machined workpiece material. Adjust the cutter suitable for the material and dimensions; as short as possible, with a short cutting length and a larger diameter. For grooving choose end mills with a smaller number of flutes (2-3) for good chip evacuation. For profiling use 4-6 flutes cutters, in order to obtain a better surface quality and durability of the cutter.

3.3. Holder

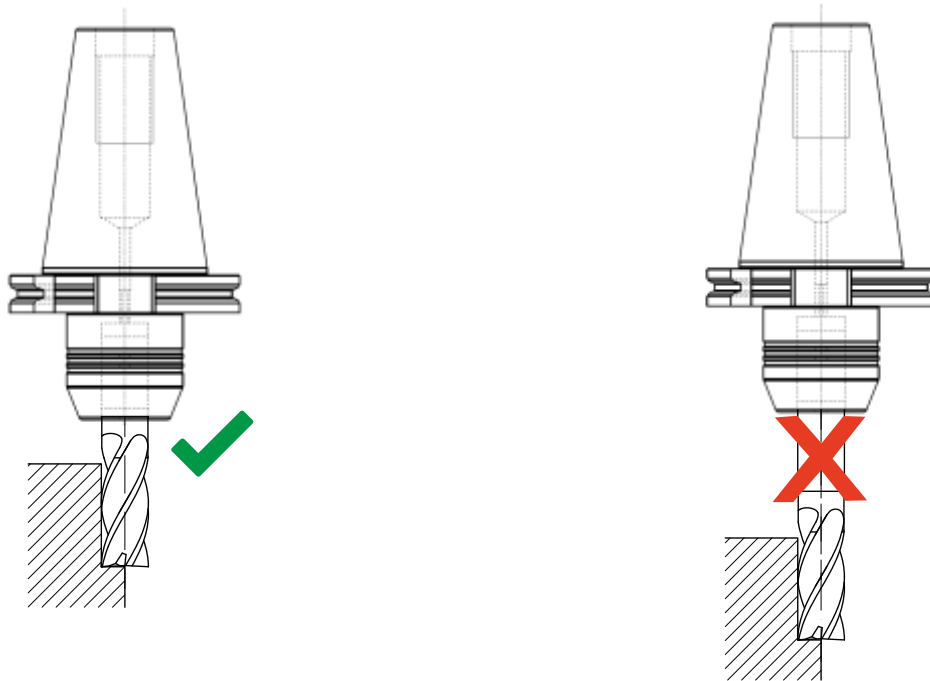

For high speed milling use the hydraulic holder or with shrink fit short reach, ensuring rigidity and precision mounting. Always secure the minimum influence of the tool holder.

3.4. Dry and wet milling

Dry milling increases the life of the cutting edge.

The milling operation in contrast to drilling is an inherently intermittent process. This causes the temperatures generated at the cutting edge to constantly fluctuate between various levels of hot and cold.

The cutting edge of a mill is subjected to thermal shocks and cyclic stresses that can result in cracking and, decreasing of tool life.

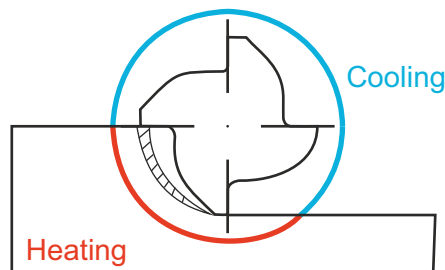

The best solution to facilitate chip removal and prevent recutting of chips is to use compressed air systems.

Justified cases of using coolant during working with carbide cutters are:

- finishing of stainless steel and aluminium
- milling of heat resistant alloys
- milling of thin walled components.

3.5. Processing technology and strategy

To increase the tool life, the climb-milling is recommended. Milling of the pockets usually begins with a pre-drill the hole. It is also used a spiral interpolation or linear ramping.

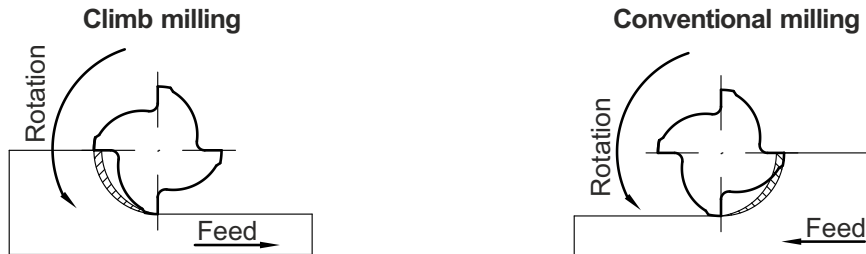

In these cases, the feed rate should be reduced to 25-50% of the values shown in the tables and cutting speed used as for grooving. In any case operating conditions can vary considerably. Therefore at the beginning of machining is recommended to reduce cutting to 50% from the tables selection, and then increasing to them. Deviations from the described conditions, exceeding the axial depth A_p and width A_e , can lead to a reduction in the cutting parameters V and f_z from those given in the tables.

3.6. High speed milling

HSM (High Speed Machining) – machining strategies based on chip thickness control and tool load reduction. By properly modifying the machining parameters, and in some cases using tools with a special design, it is possible to achieve lower mechanical and thermal load of cutting edges while increasing productivity.

Influence of the cutting width on the thickness of the chip.

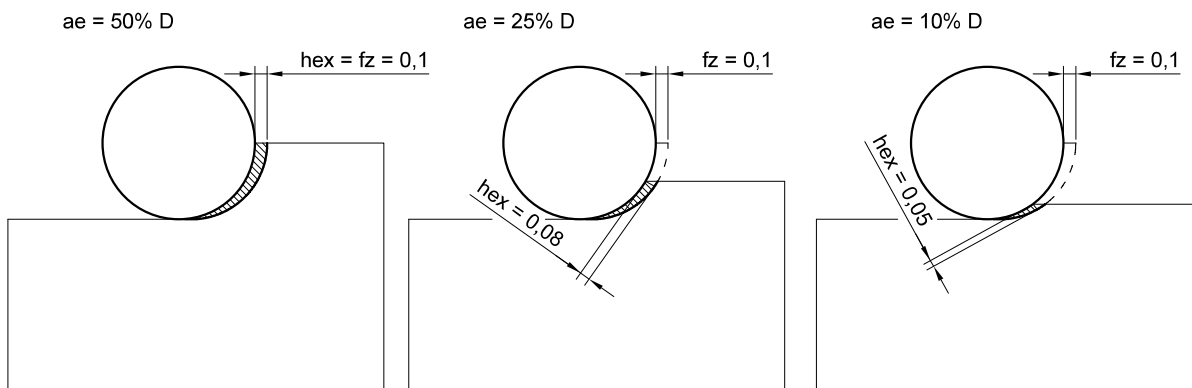

The most common milling strategies based on chip thickness control are:

- Trochoidal milling
- High Feed Milling (HFM)

3.6.1. Trochoidal milling

High Feed Milling - Milling strategy developed to reduce chip thickness by using a tool with a special face geometry. This kind of a tool allows machining with several times higher feed rates than conventional machining.

- **Very small milling width a_e and small wrap angle of the tool** - reduction of chip thickness hex and radial forces
- **Highest possible cutting speed V_c and number of flutes** - high feed speeds and productivity
- **Full length of cutting edges in use** – even wear of cutting edges

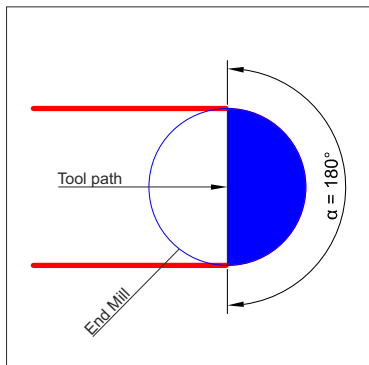

Milling a groove in a full material

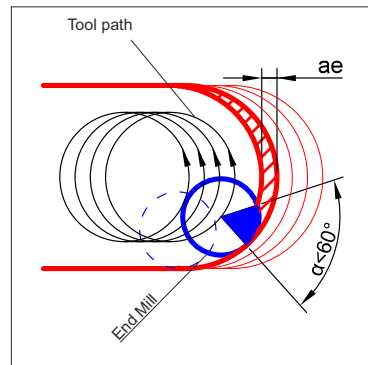

Trochoidal milling

3.6.2. HFM - High Feed Milling

High Feed Milling - Milling strategy developed to reduce chip thickness by using a tool with a special face geometry. This kind of a tool allows machining with several times higher feed rates than conventional machining.

- **Very low cutting depth a_p** - reduced chip thickness hex and radial forces
- **Large cutting width a_e and feed per tooth f_z** - even wear of the specially shaped cutting edge
- **Highest possible feed per tooth and number of teeth** - high feed speeds and productivity

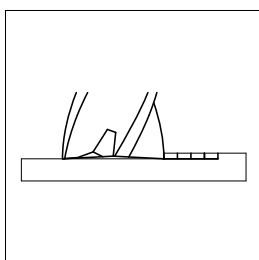

Face of standard end mill

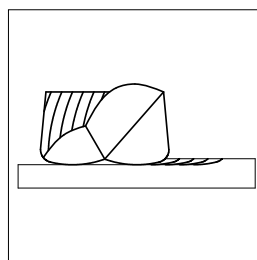

Face of milling cutter for High Feed Milling

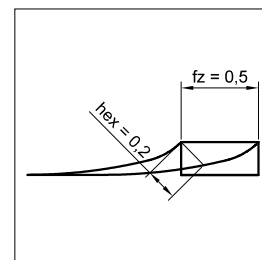

Comparison of the chip shape with the same feed per tooth

3.6.3. Machine requirements:

- High speed spindle
- High dynamics of the machine - frequent changes of direction and feed values
- Balancing tools with a tool holder
- Necessity to be able to program the toolpath - CAM software
- Proper tool design

4. Formula and tables

4.1. Basic formulas

Symbol	Unit	Name	Formula
V_c	m/min	Cutting speed	$v_c = \frac{d_1 \times \pi \times n}{1000}$
n	1/min	Rotational speed	$n = \frac{1000 \times v_c}{d_1 \times \pi}$
V_f	mm/min	Rate of feed	$v_f = f_z \times n \times z$
f_z	mm	Feed per tooth	$f_z = \frac{v_f}{n \times z}$

d_1 [mm] - diameter of milling cutters

z - number of teeth

4.2. Ball nose end mills real cutting diameter

Ø d1	Depth of cut a_p [mm]																
	0,01	0,02	0,03	0,04	0,05	0,08	0,1	0,15	0,2	0,3	0,5	0,8	1,0	2,0	3,0	4,0	5,0
1	0,199	0,280	0,341	0,392	0,436	0,543	0,600	0,714	0,800	0,917	1,000	-	-	-	-	-	-
2	0,282	0,398	0,486	0,560	0,624	0,784	0,872	1,054	1,200	1,428	1,732	1,960	2,000	-	-	-	-
3	0,346	0,488	0,597	0,688	0,768	0,967	1,077	1,308	1,497	1,800	2,236	2,653	2,828	2,828	-	-	-
4	0,399	0,564	0,690	0,796	0,889	1,120	1,249	1,520	1,744	2,107	2,646	3,200	3,464	4,000	-	-	-
5	0,447	0,631	0,772	0,891	0,995	1,255	1,400	1,706	1,960	2,375	3,000	3,666	4,000	4,899	4,899	-	-
6	0,489	0,692	0,846	0,977	1,091	1,376	1,536	1,873	2,154	2,615	3,317	4,079	4,472	5,657	6,000	-	-
8	0,565	0,799	0,978	1,129	1,261	1,592	1,778	2,170	2,498	3,040	3,873	4,800	5,292	6,928	7,746	8,000	-
10	0,632	0,894	1,094	1,262	1,411	1,782	1,990	2,431	2,800	3,412	4,359	5,426	6,000	8,000	9,165	9,798	10,000
12	0,693	0,979	1,198	1,383	1,546	1,953	2,182	2,666	3,072	3,747	4,796	5,987	6,633	8,944	10,392	11,314	11,832
14	0,748	1,058	1,295	1,495	1,670	2,111	2,358	2,883	3,323	4,055	5,196	6,499	7,211	9,798	11,489	12,649	13,416
16	0,800	1,131	1,384	1,598	1,786	2,257	2,522	3,084	3,555	4,341	5,568	6,974	7,746	10,583	12,490	13,856	14,832
18	0,848	1,199	1,468	1,695	1,895	2,395	2,676	3,273	3,774	4,609	5,916	7,419	8,246	11,314	13,416	14,967	16,125
20	0,894	1,264	1,548	1,787	1,997	2,525	2,821	3,451	3,980	4,862	6,245	7,838	8,718	12,000	14,283	16,000	17,321

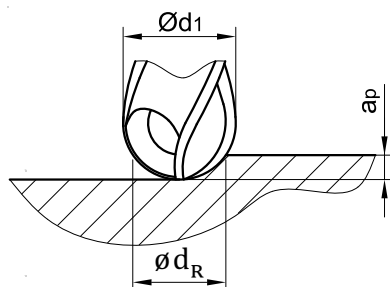

$$\text{Ø}d_R = 2 \cdot \sqrt{a_p (\text{Ø}d_1 - a_p)}$$



Tool Factory FANAR Joint Stock Company



Płocka 11 street, 06-400 Ciechanów POLAND

tel.: (48 23) 672 44 44, fax: (48 23) 672 48 41

email: info@fanar.pl, www.fanar.eu

Export Department

tel.: (48 23) 674 30 03 

(48 23) 674 30 35  

(48 23) 672 42 62 

email: export@fanar.pl



All rights reserved. Reprinting or copying it wholly or partially is permitted only with the consent of FANAR S.A.
Mistakes resulting from improper interpretation or printing errors do not entitle to any claims.
We reserve ourselves the right to implement technical changes.
